

<b>Title</b>	<b><i>Reference Design Report for a 60 W Isolated Flyback Power Supply Using InnoSwitch™3-AQ INN3949CQ</i></b>
<b>Specification</b>	50 – 1000 VDC Input; 50 VDC: 4 W 100 VDC: 35 W 200 VDC: 48 W 300 VDC – 1000 VDC: 60 W
<b>Application</b>	High Input Voltage for Automotive Application
<b>Author</b>	Applications Engineering Department
<b>Document Number</b>	RDR-919Q
<b>Date</b>	February 10, 2023
<b>Revision</b>	1.1

#### **Summary and Features**

- High input voltage: up to 1000 VDC
- Works in extreme hot condition: 85 °C with continuous 20 W operation at 1000 VDC input
- InnoSwitch™3-AQ – industry first AC/DC ICs with isolated, safety rated integrated feedback
- Built-in synchronous rectification for >82% efficiency
- All the benefits of secondary-side control with the simplicity of primary-side regulation
  - Insensitive to transformer variation
  - Extremely fast transient response independent of load timing

#### **PATENT INFORMATION**

The products and applications illustrated herein (including transformer construction and circuits external to the products) may be covered by one or more U.S. and foreign patents, or potentially by pending U.S. and foreign patent applications assigned to Power Integrations. A complete list of Power Integrations' patents may be found at [www.power.com](http://www.power.com). Power Integrations grants its customers a license under certain patent rights as set forth at <https://www.power.com/company/intellectual-property-licensing/>.

---

#### **Power Integrations**

5245 Hellyer Avenue, San Jose, CA 95138 USA.  
Tel: +1 408 414 9200 Fax: +1 408 414 9201  
[www.power.com](http://www.power.com)

## Table of Contents

1	Introduction.....	4
2	Power Supply Specification.....	5
3	Schematic.....	6
4	Circuit Description .....	7
4.1	<i>INN3949CQ IC Primary</i> .....	7
4.2	<i>INN3949CQ IC Secondary</i> .....	7
5	PCB Layout.....	9
6	Bill of Materials .....	13
7	Transformer Design.....	14
7.1	<i>Electrical Diagram</i> .....	14
7.2	<i>Electrical Specification</i> .....	14
7.3	<i>Materials List</i> .....	14
7.4	<i>Transformer Build Diagram</i> .....	15
7.5	<i>Transformer Instruction</i> .....	15
7.6	<i>Winding Illustrations</i> .....	16
7.7	<i>Transformer Design Spreadsheet</i> .....	22
8	Performance Data .....	26
8.1	<i>Efficiency vs. Load and Input Voltage</i> .....	26
8.2	<i>Full Load Efficiency vs. Line</i> .....	29
8.3	<i>Maximum Power at Low Input Voltage</i> .....	30
8.4	<i>No-Load Input Power</i> .....	30
8.5	<i>Load and Line Regulation</i> .....	31
9	Waveforms .....	34
9.1	<i>INN3949CQ Drain Voltage and Current, Steady-State</i> .....	34
9.2	<i>INN3949CQ Drain Voltage and Current, Start-up</i> .....	35
9.3	<i>INN3949CQ Drain Voltage and Current, Output Shorted</i> .....	36
9.4	<i>SR FET Waveforms, Steady-State</i> .....	37
9.5	<i>SR FET Waveforms, Start-up</i> .....	38
9.6	<i>SR FET Waveforms, Output Shorted</i> .....	39
9.7	<i>Output Ripple Measurements</i> .....	40
9.7.1	100% Loading Condition.....	41
9.7.2	75% Loading Condition .....	42
9.7.3	50% Loading Condition .....	43
9.7.4	25% Loading Condition .....	44
9.7.5	0% Loading Condition .....	45
9.8	<i>Output Voltage Ripple (ATE)</i> .....	46
9.9	<i>Output Load Transient</i> .....	49
9.9.1	Output Load Transient, 100% to 50% Load .....	49
9.9.2	Output Load Transient, 100% to 0% Load .....	50
9.10	<i>FWD Waveforms, Steady-State</i> .....	51
9.11	<i>FWD Waveforms, Start-up</i> .....	52
9.12	<i>FWD Waveforms, Output Shorted</i> .....	53



---

10	Thermal Performance.....	54
10.1	<i>Temperature vs. Output Power</i> .....	55
10.2	<i>Maximum Output Power vs. Ambient Temperature</i> .....	58
11	Revision History.....	59

**Important Note:**

Although this board is designed to satisfy safety isolation requirements, the engineering prototype has not been agency approved. Therefore, all testing should be performed using a high voltage DC Supply to provide the DC input to the prototype board.



## 1 Introduction

This engineering report describes a 50 VDC to 1000 VDC input, 24 V output, 60 W power supply utilizing INN3949CQ from Power Integrations. The document contains the power supply specification, schematic, bill-of-materials and basic performance data.

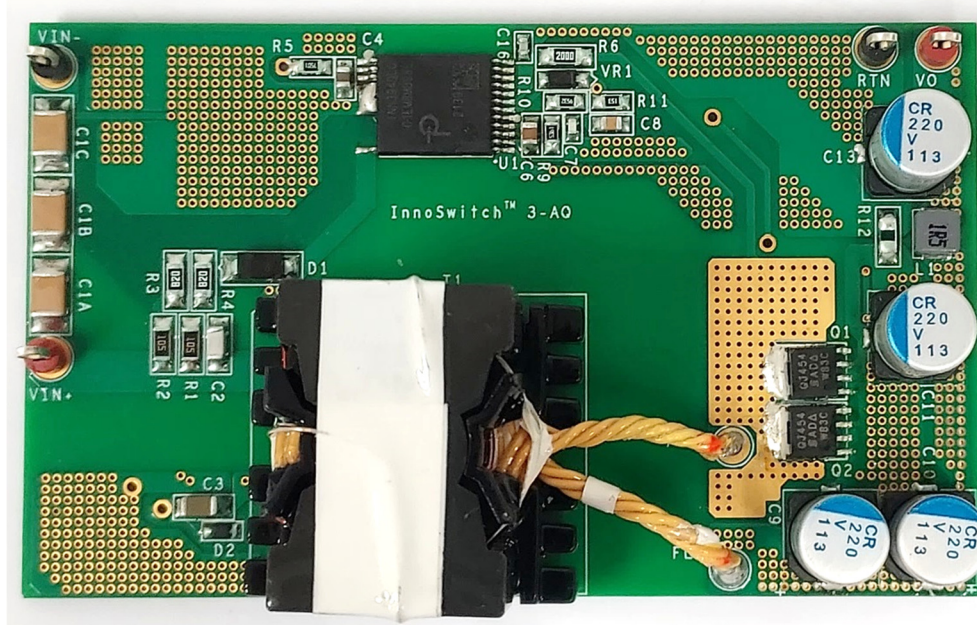


Figure 1 – Populated Circuit Board Photograph, Top.

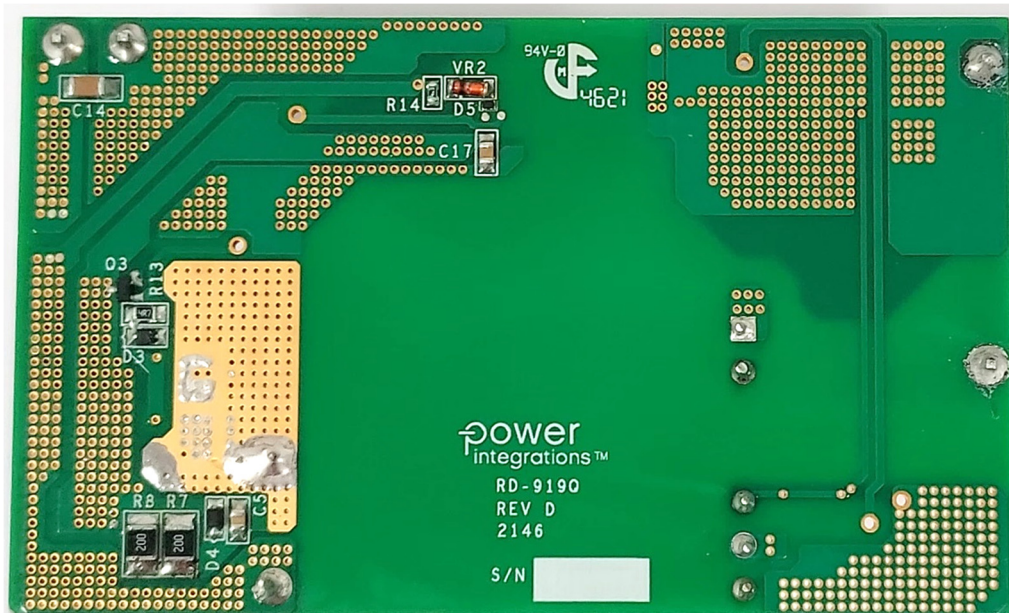


Figure 2 – Populated Circuit Board Photograph, Bottom.



## 2 Power Supply Specification

The table below represents the minimum acceptable performance of the design. Actual performance is listed in the results section.

Description	Symbol	Min	Typ	Max	Units	Comment
<b>Input</b>						
Voltage	$V_{IN}$	300	800	1000	VDC	For Electric Vehicle Emergency PSU. For 60 W Output Power.
No-load Input Power				30	mW	
<b>Output</b>						
Output Voltage	$V_{OUT}$		24		V	±5%
Output Current	$I_{OUT}$		2.5		A	
Output Ripple Voltage	$V_{RIPPLE}$			240	mV	On Board. ( $V_{IN}$ 300 VDC to 1000 VDC.)
<b>Total Output Power</b>						
Continuous Output Power	$P_{OUT}$			4	W	$V_{IN}$ of 50 VDC.
Continuous Output Power	$P_{OUT}$			35	W	$V_{IN}$ of 100 VDC.
Continuous Output Power	$P_{OUT}$			48	W	$V_{IN}$ of 200 VDC.
Continuous Output Power	$P_{OUT}$			60	W	$V_{IN}$ 300 VDC to 1000 VDC.
<b>Ambient Temperature</b>	$T_{AMB}$	-40		85	°C	Inside Inverter.



### 3 Schematic

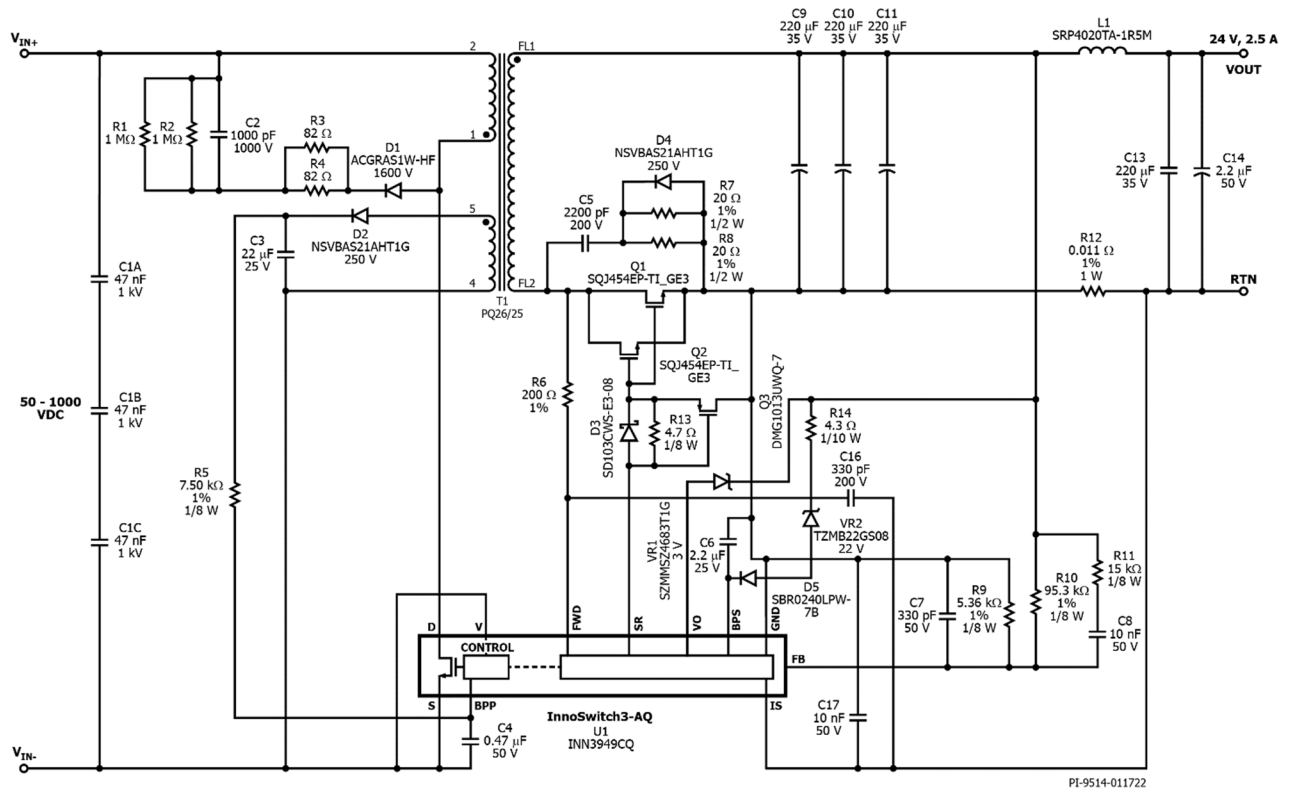


Figure 3 – Schematic.

## 4 Circuit Description

### 4.1 *INN3949CQ IC Primary*

One end of the transformer primary is connected to the DC bus, the other is connected to the integrated power MOSFET inside the INN3949CQ IC (U1). High-voltage ceramic capacitors C1A, C1B and C1C are used for the decoupling capacitors for the DC input voltage, and a low-cost RCD clamp formed by D1, R1, R2, R3, R4 and C2 limits the peak Drain voltage due to transformer leakage inductance effect.

The IC is self-starting, using an internal high-voltage current source to charge the BPP pin capacitor, C4, when DC input voltage is first applied. During normal operation the primary-side block is powered from an auxiliary winding on the transformer. The output is configured as a flyback winding, which is rectified and filtered using diode D2 and capacitor C3, fed the BPP pin capacitor via a current limiting resistor R5.

In this design the input primary under and overvoltage features were disabled by connecting the V pin to source.

### 4.2 *INN3949CQ IC Secondary*

The secondary-side of the INN3949CQ IC provides output voltage, output current sensing, and drive a MOSFET providing synchronous rectification.

The 24 V output rectification is provided by SR FETs Q1 and Q2. Low ESR capacitors, C9, C10, C11, C13, C14 and output inductor L1 provide filtering. RC snubber network comprising D4, R7, R8, and C5 for Q1 and Q2 damps high frequency ringing across SR FETs, which results from leakage inductance of the transformer windings and the secondary trace inductances. The gates of Q1 and Q2 are turned on based on the winding voltage sensed via R6 and the FWD pin of the IC. Capacitor C16 is used to suppress high frequency spikes on the FWD pin. In continuous conduction mode operation, the power MOSFET is turned off just prior to the secondary-side controller commanding a new switching cycle from the primary. In discontinuous mode the MOSFET is turned off when the voltage drop across the MOSFET falls below ground. Secondary-side control of the primary-side MOSFET ensures that it is never on simultaneously with the synchronous rectification MOSFET. The MOSFET drive signal is output on the SR pin. A gate enhancement circuit comprising D3, R13 and Q3 prevents Vgs to turn-on during primary turn-ons. The secondary-side of the IC is self-powered from either the secondary winding forward voltage or the output voltage. The output voltage powers the device, fed into Zener VR1 which is connected to the VO pin. Zener VR1 is used to reduce the voltage stress on the VO pin. It will charge the BPS pin capacitor C6 via an internal regulator. The OVP sensing circuit, R14, VR2 and D5, connected to BPS pin provides secondary-side overvoltage protection.



Resistors R9 and R10 form a voltage divider network that senses the output voltage. INN3949CQ IC has an internal reference of 1.265 V. Capacitor C7 provides decoupling from high frequency noise affecting power supply operation, and C8 and R11 is the feedforward network to speed up the response time to lower the output ripple. The output current is sensed by R12 and filtered by C17 with a threshold of approximately 35 mV to reduce losses. Once the current sense threshold across this resistor is exceeded, the device will go into auto-restart.



## 5 PCB Layout

Layers: 4  
 Board Thickness: 0.062"  
 Board Material: FR4  
 Copper Weight: 2 oz  
 Surface finish: LF HASL

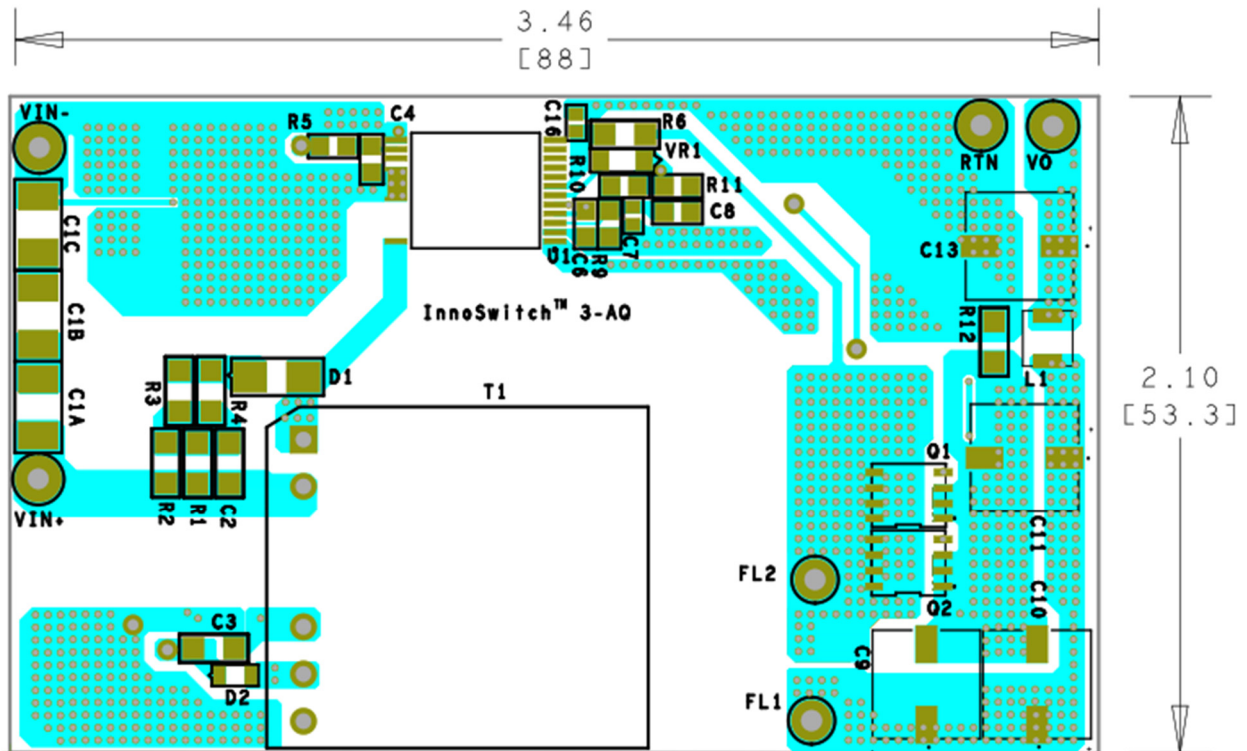


Figure 4 – Printed Circuit Board Layout (Top).



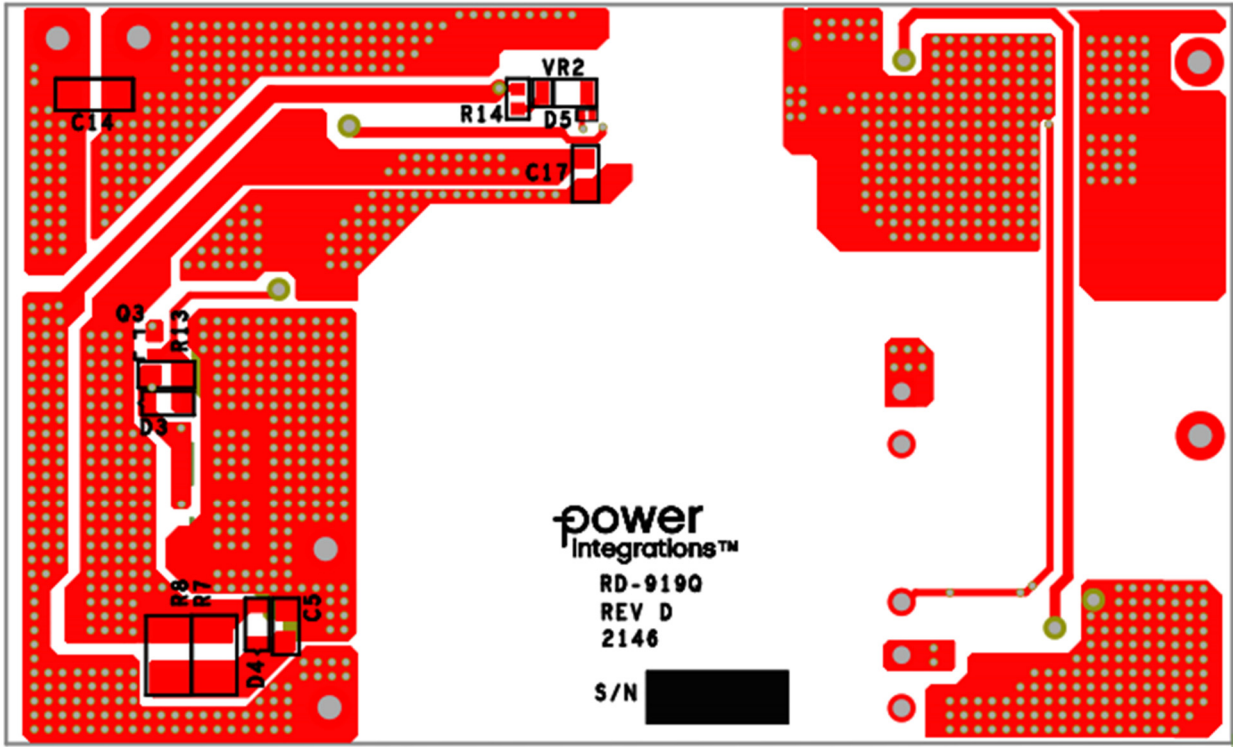
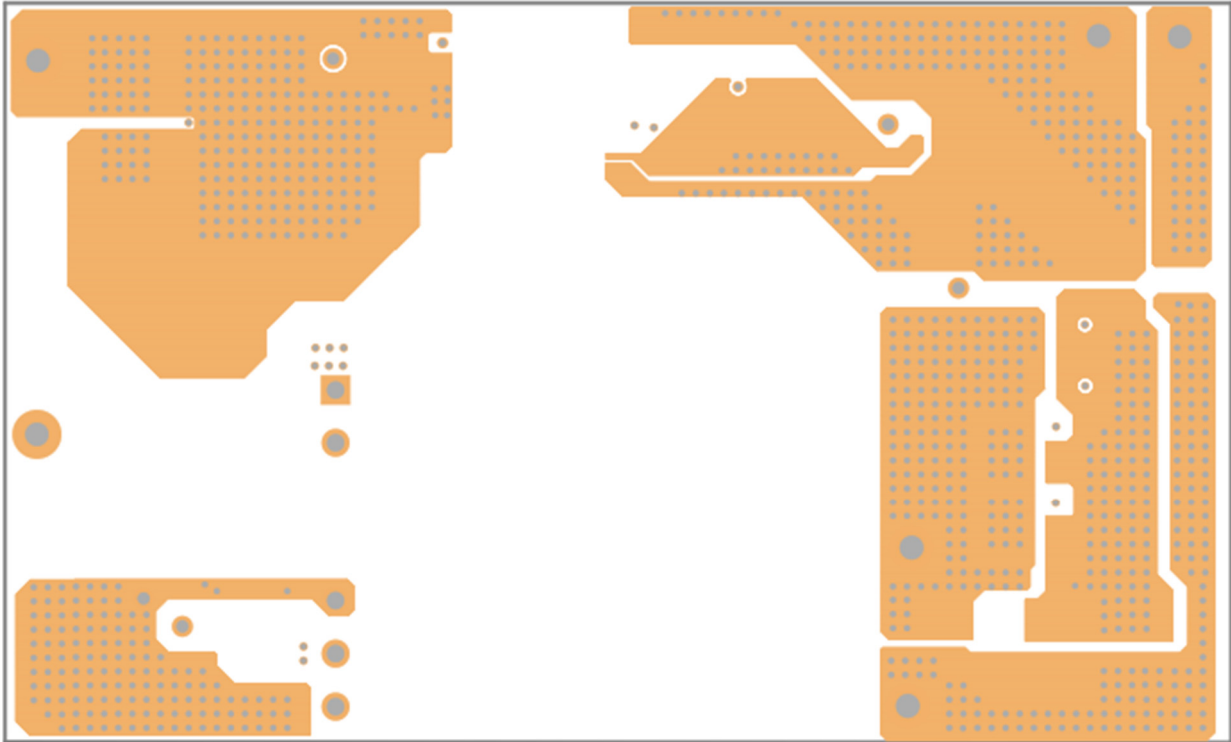
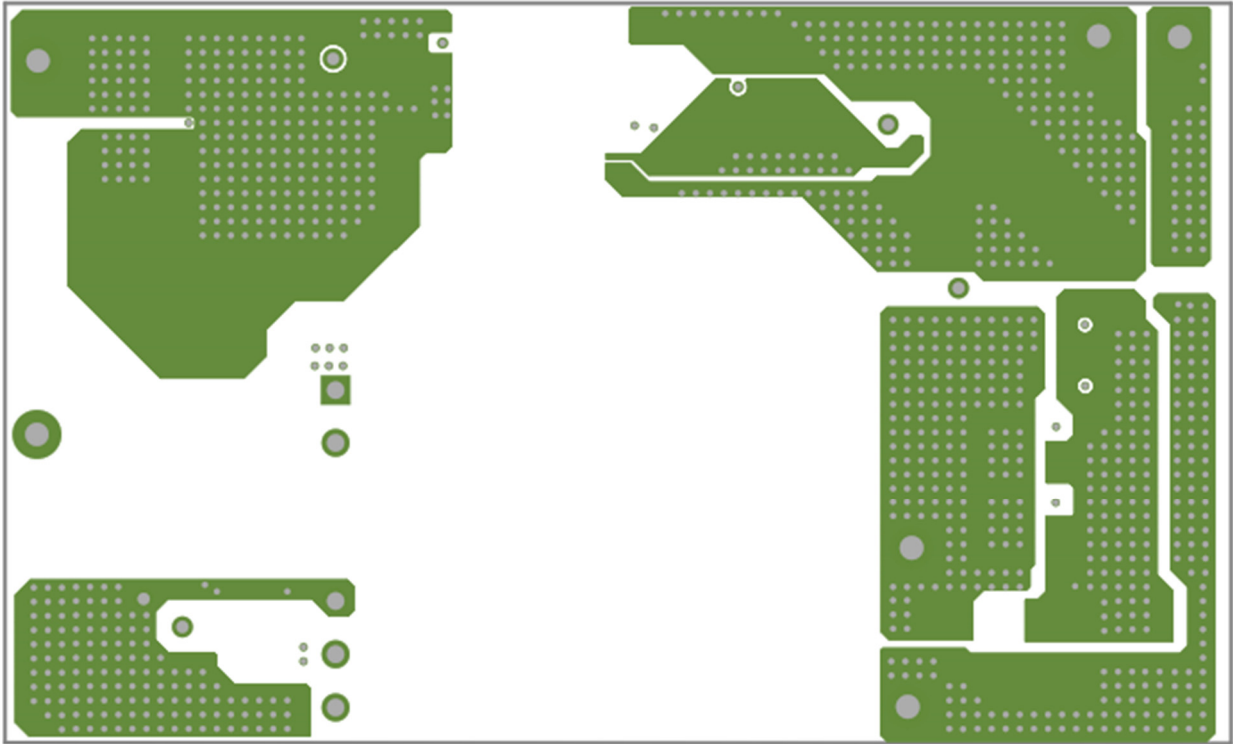


Figure 5 – Printed Circuit Board Layout (Bottom).



**Figure 6** – Printed Circuit Board Layout (Internal layer 1).



**Figure 7** – Printed Circuit Board Layout (Internal layer 2).

## 6 Bill of Materials

Item	Qty	Ref Des	Description	Mfg Part Number	Mfg
1	1	C2	1000 pF, ±10%, 1000 V (1 kV), Ceramic, C0G, NP0 1206 (3216 Metric)	C1206C102KDGACAUTO	Kemet
2	1	C3	22 µF, ±20%, 25 V, Ceramic, X5R, 1206 (3216 Metric)	12063D226MAT2A	AVX
3	1	C4	0.47 µF, ±10%, .50 V, Ceramic, X7R, 0805 (2012 Metric), -55 °C ~ 125 °C	CGA4J3X7R1H474K125AB	TDK
4	1	C5	2200 pF, ±10%, 200 V, Ceramic, X7R, 0805 (2012 Metric)	08052C222K4T2A	AVX
5	1	C6	2.2 µF ±10% 25 V Ceramic X7R 0805 (2012 Metric)	GCM21BR71E225KA73L	Murata
6	1	C7	330 pF, ±5%, 50 V, Ceramic, C0G, NP0, 0603 (1608 Metric)	C0603C331J5GACAUTO	KEMET
7	2	C8 C17	10 nF, 50 V, Ceramic, X7R, 0805	C0805C103K5RACTU	Kemet
8	4	C9 C10 C11 C13	220 µF, 20%, 35 V, Aluminum - Polymer, (8.30 mm x 8.30 mm), Height 0.472" (12.00 mm), SMD	PCR1V221MCL1GS	Nichicon
9	1	C14	2.2 µF, ±10%, 50 V, Ceramic, X7R, Bypass, Decoupling, 1206 (3216 Metric)	C1206C225K5RACAUTO7210	KEMET
10 Alt.	1 1	C16 C16	330 pF ±5%, 200 V, Ceramic, C0G, NP0, 0603 (1608 Metric) 330 pF ±5%, 200 V, Ceramic, C0G, NP0, 0805 (2012 Metric)	CGJ3E3C0G2D331J080AA C0805C331J2GACAUTO	TDK Corp Kemet
11	3	C1A C1B C1C	0.047 µF, ±10%, 1000 V (1 kV), Ceramic, X7R, 1812 (4532 Metric)	1812Y1K00473KST	Knowles Syfer
12	1	D1	Diode Standard 1600 V 1 A Surface Mount DO-214AC (SMA)	ACGRAS1W-HF	Comchip
13 Alt.	2 2	D2 D4 D2 D4	Diode, Standard, 250 V, 200 mA, SC-76, SOD-323 Diode, Standard, 200 V, 200 mA (DC), SOD-323, SC-17	NSVBAS21AHT1G SBAS20HT1G	ON Semi ON Semi
14 Alt.	1 1	D3 D3	Diode, Schottky, 20 V, 350 mA (DC), SMT, SOD-323 SC-76 Diode, Schottky, 40 V, 350 mA (DC), SMT, SOD-323 SC-76	SD103CWS-E3-08 SD103AWS-HE3-08	Vishay Vishay
15	1	D5	Diode Standard 40 V 200 mA Surface Mount X1-DFN1006-2	SBR0240LPW-7B	Diodes Incorporated
16	2	FL1 FL2	Flying Lead, Hole size 70 mils	N/A	N/A
17	1	L1	1.5 µH, ±20%, Shielded, Wirewound, Inductor, 4.5 A, 42 mΩ Max, Automotive, AEC-Q200, 2-SMD	SRP4020TA-1R5M	Bourns
18	2	Q1 Q2	MOSFET, N-Channel, 200 V, 13 A (Tc), 68 W (Tc), Automotive, AEC-Q101, PowerPAK® SO-8	SQJ454EP-T1_GE3	Vishay
19	1	Q3	MOSFET, P-Channel 20 V, 820 mA (Ta), 310 mW (Ta), SMT, SC-70, SOT-323	DMG1013UWQ-7	Diodes Incorporated
20	2	R1 R2	RES, 1 MΩ, ±5%, ¼ W Chip, 1206 (3216 Metric), High Voltage Thick Film	KTR18EZPJ105	Rohm Semi
21	2	R3 R4	RES, 82 Ω, 5%, 1/4 W, Thick Film, 1206	ERJ-8GEYJ820V	Panasonic
22	1	R5	RES, 7.50 kΩ, 1%, 1/8 W, Thick Film, 0805	ERJ-6ENF7501V	Panasonic
23	1	R6	RES, 200 Ω, 1%, 1/4 W, Thick Film, 1206	ERJ-8ENF2000V	Panasonic
24	2	R7 R8	RES, 20 Ω ±1% 0.5W, Thick Film1210	CRCW121020R0FKEA	Vishay Dale
25	1	R9	RES, 5.36 kΩ, 1%, 1/8 W, Thick Film, 0805	ERJ-6ENF5361V	Panasonic
26	1	R10	RES, 95.3 kΩ, 1%, 1/8 W, Thick Film, 0805	ERJ-6ENF9532V	Panasonic
27	1	R11	RES, 15 kΩ, 5%, 1/8 W, Thick Film, 0805	ERJ-6GEYJ153V	Panasonic
28	1	R12	0.011 Ω, ±1%, ±75ppm/°C, 1 W, 1206, Automotive AEC-Q200, Current Sense, -55 °C ~ 155 °C	ERJ-8CWFRO11V	Panasonic
29	1	R13	RES, 4.7 Ω, 5%, 1/8 W, Thick Film, 0805	ERJ-6GEYJ4R7V	Panasonic
30	1	R14	RES, 4.3 Ω, 5%, 1/10 W, Thick Film, 0603	ERJ-3GEYJ4R3V	Panasonic
31	2	RTN VIN-	Test Point, BLK, THRU-HOLE MOUNT	5011	Keystone
32	1	T1	Bobbin, PQ26/25, Vertical, 12 pins Transformer	PQ26X25 POL-INN053	Pin Shine Premier Magnetics
33	1	U1	InnoSwitch3-AQ, 1700 V, InSOP-24D	INN3949CQ	Power Integrations
34	1	VR1	Diode Zener 3 V 500 mW SOD123	SZMMSZ4683T1G MMSZ5225BT1G	ON Semi
35	1	VR2	Diode Zener 22 V 500 mW SOD80	TZMB22-GS08	Vishay
36	2	VIN+ VO	Test Point, RED, THRU-HOLE MOUNT	5010	Keystone



## 7 Transformer Design

### 7.1 Electrical Diagram

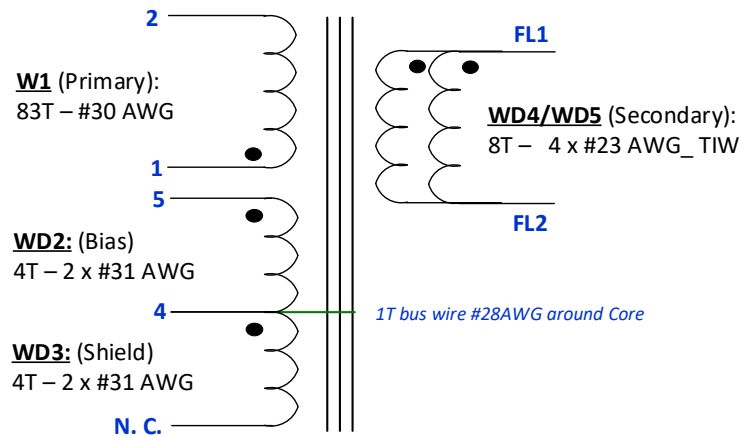


Figure 8 – Electrical Diagram.

### 7.2 Electrical Specification

Parameter	Condition	Spec.
Electrical Strength	60 seconds, 10 mA, from pins 1-6 to FL1 & FL2.	3000 VAC
Nominal Primary Inductance	Measured at 1 V <sub>PK-PK</sub> , 100 kHz switching frequency, between pin 1 and 2, with all other windings open.	1735 $\mu$ H $\pm$ 5%
Resonant Frequency	Between pin 1 and 2, other windings open.	550 kHz (Min.)
Primary Leakage Inductance	Between pin 1 and 2, with pins: FL1-FL2 shorted.	30 $\mu$ H (Max.)

### 7.3 Materials List

Item	Description
[1]	Core: PQ26/25 – TDK PC95.
[2]	Bobbin: PQ26/25 – Vertical – 12 pins (6/6); PI#: 25-00055-00; or Equivalent.
[3]	Magnet Wire: #30 AWG, Double Coated.
[4]	Magnet Wire: #31 AWG, Double Coated.
[5]	Magnet Wire: #23 AWG, Triple Insulated Wire.
[6]	Bus Wire: #28 AWG, Alpha Wire, Tinned Copper.
[7]	Tape: 3M 13450-F, Polyester Film, 1 mil Thickness, 13.5 mm Width.
[8]	Varnish: Dolph BC-359.



## 7.4 Transformer Build Diagram

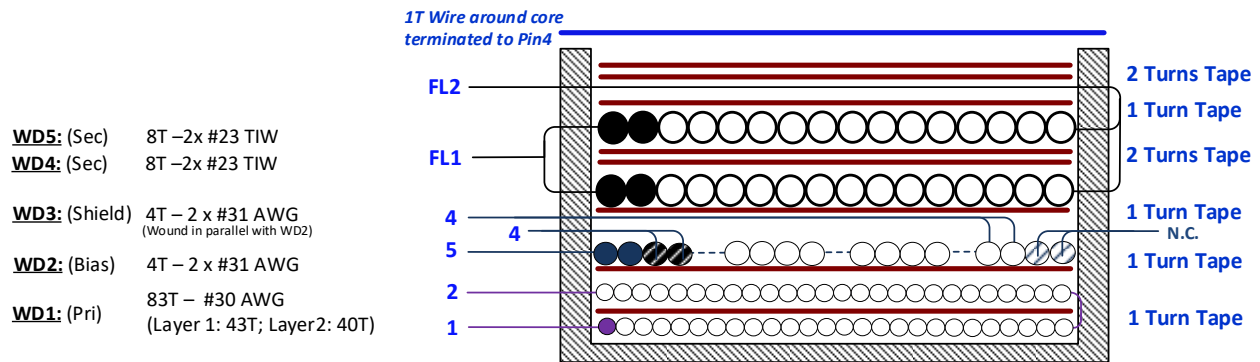
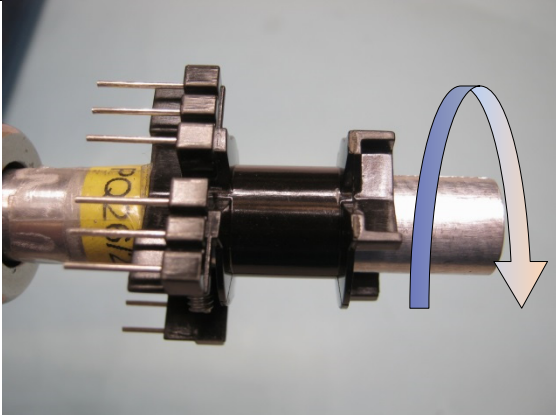
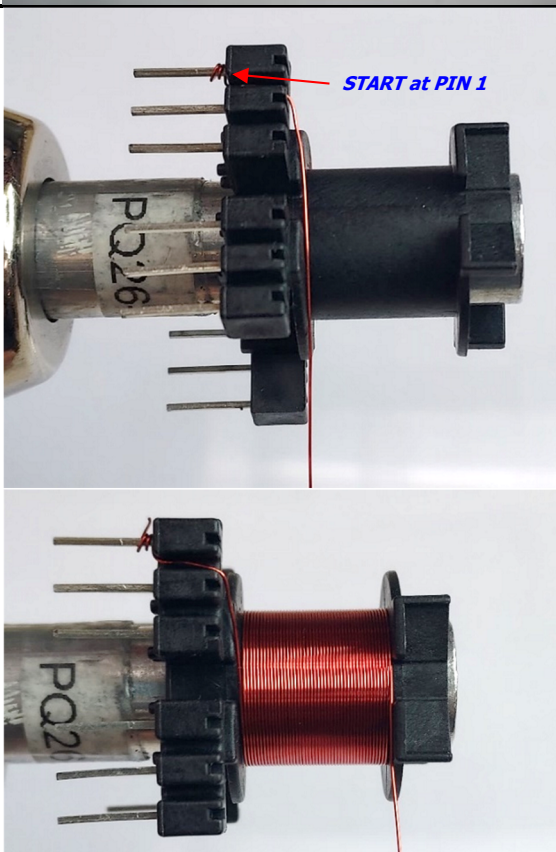


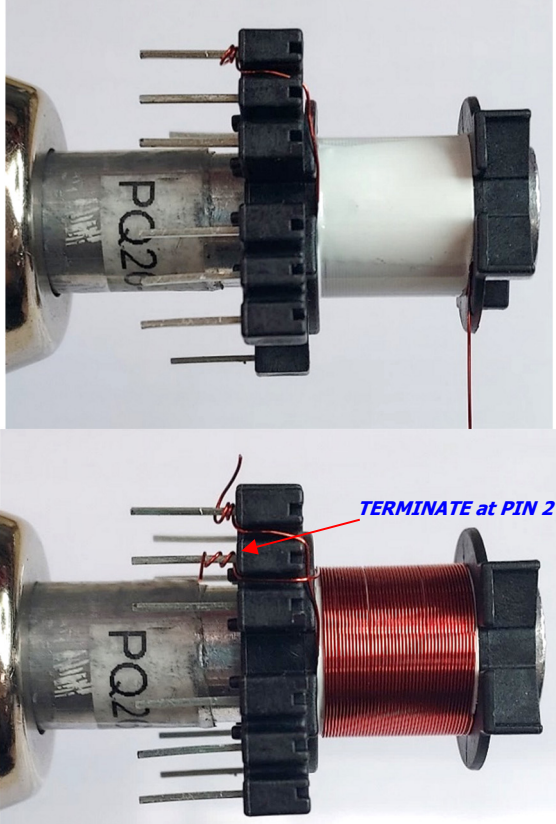
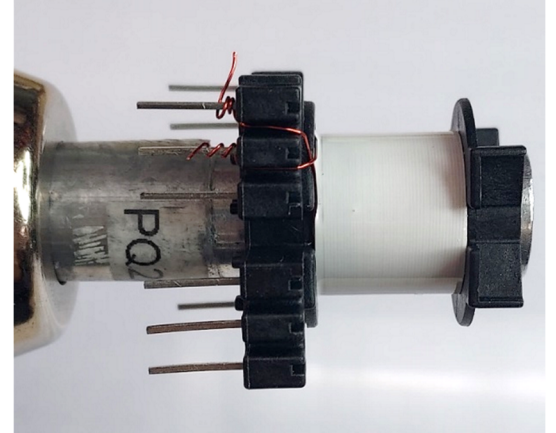
Figure 9 – Transformer Build Diagram.

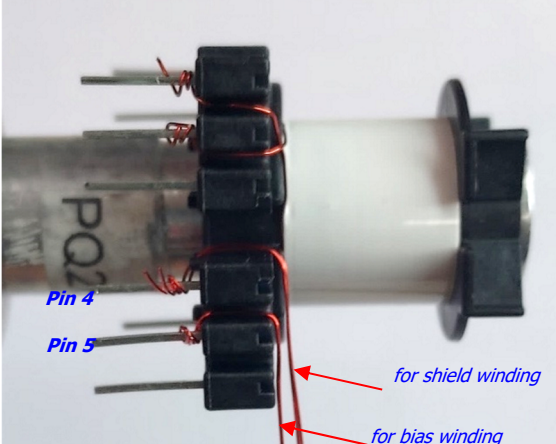
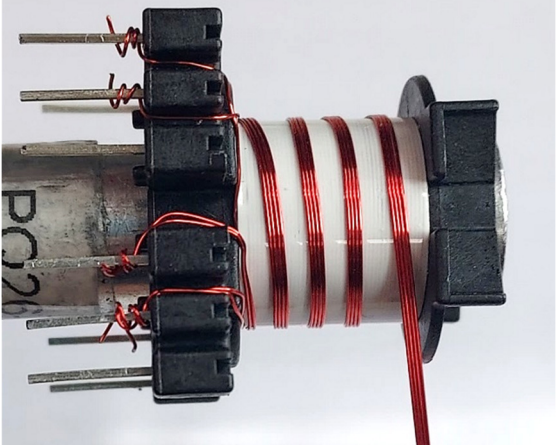
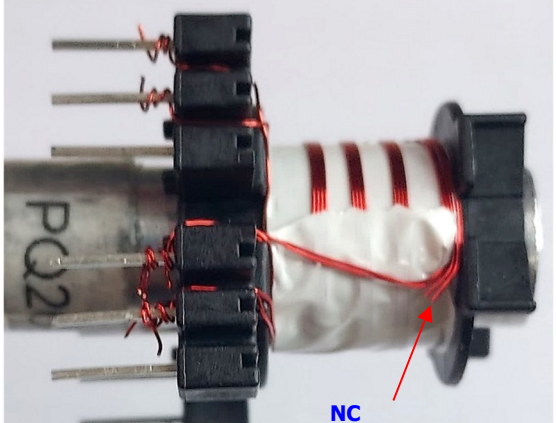
## 7.5 Transformer Instruction

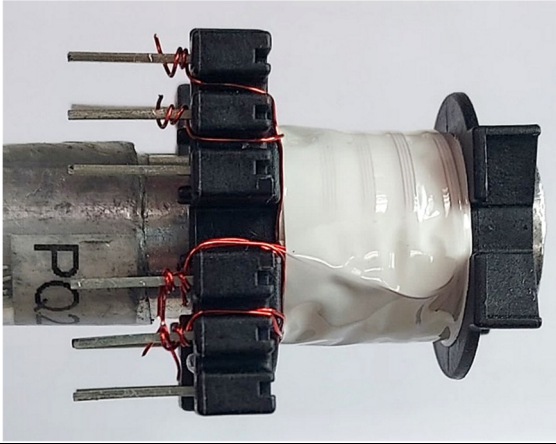
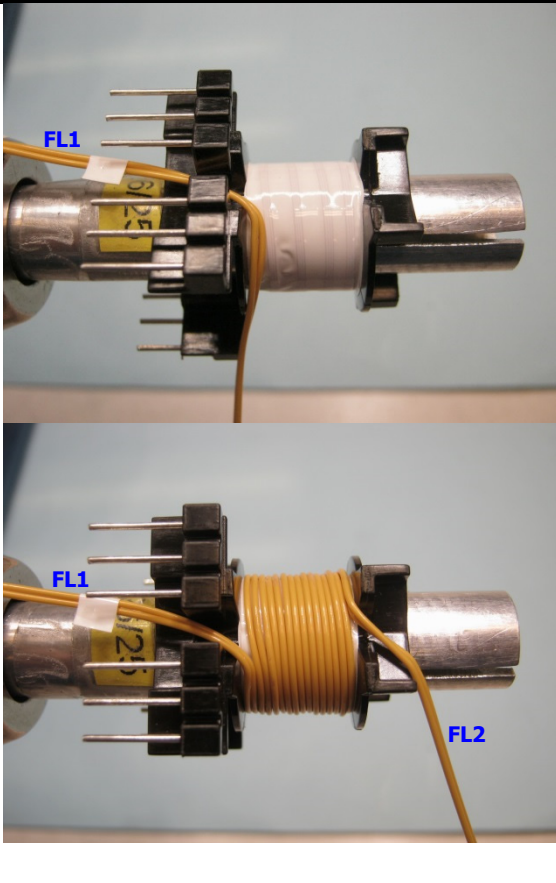
<b>Winding Preparation</b>	Position the bobbin Item [2] on the mandrel such that the primary side of the bobbin is on the left side. Winding direction is clockwise direction.
<b>WD1 1st Primary</b>	Start at pin 1, wind 43 turns of wire Item [3] with tight tension, from left to right, and place 1 layer of tape Item [7]. Continue wind another 40T from right to left, at the last turn, terminate this wire at pin 2.
<b>Insulation</b>	1 layer of tape Item [7].
<b>WD2: Bias &amp; WD3: Shield</b>	Use 2 wires Item [4] start at pin 5 for Bias winding, also use 2 wires same Item [4] start at pin 4 for Shield winding. Wind all 4 wires in parallel and together; spread the wires evenly on the bobbin. At the 4th turn: <ul style="list-style-type: none"> <li>- bring 2 wires for Bias winding to the left and terminate at pin 4,</li> <li>- cut short 2 wires for Shield Winding as No-Connect.</li> </ul>
<b>Insulation</b>	1 layer of tape Item [7].
<b>WD4 Secondary</b>	Start at left slot of secondary side of bobbin, use 2 wires Item [5] leaving ~1", mark as FL1, and wind 8 turns with tight tension. At the last turn, exit the wire at the right slot, also leaving ~ 2" and mark as FL2.
<b>Insulation</b>	Place 2 layers of tape Item [7].
<b>WD5 Secondary</b>	Repeat same winding above and on top, also start as FL1 and end FL2.
<b>Insulation</b>	Place 1 layer of tape Item [7], bring 4 wires floating FL2 from Secondary – WD3 to left slot and continue placing another 2 layers of tape to secure these wires and all the windings.
<b>Finish</b>	Gap core halves to get 1735 $\mu$ H. Use 2" of bus wire Item [6], solder to pin 4 then lean along core halves and secure with tape. Remove pins 3, 7, 8, 9, 10, 11 & 12. Varnish with Item [8].

7.6 **Winding Illustrations**

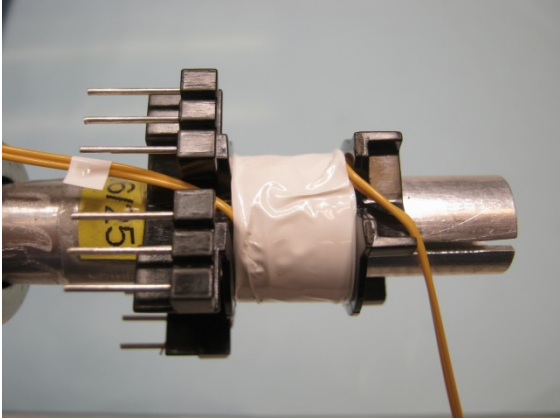
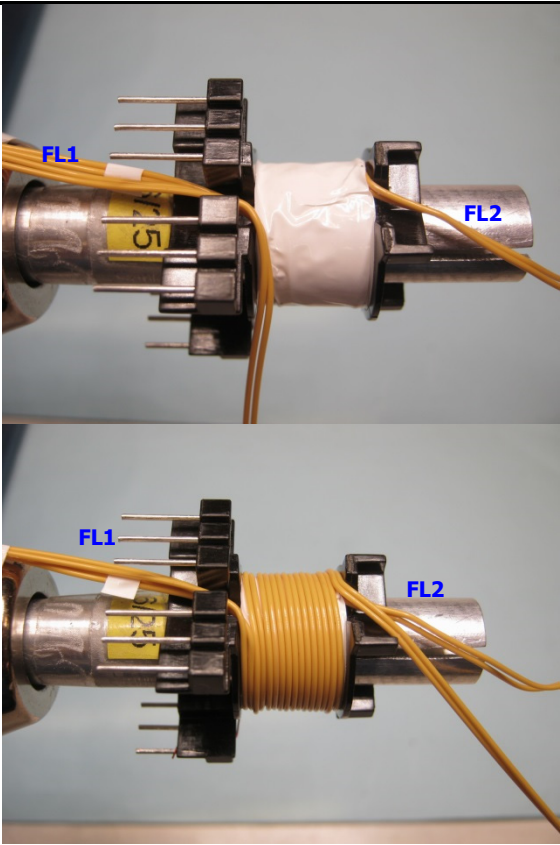
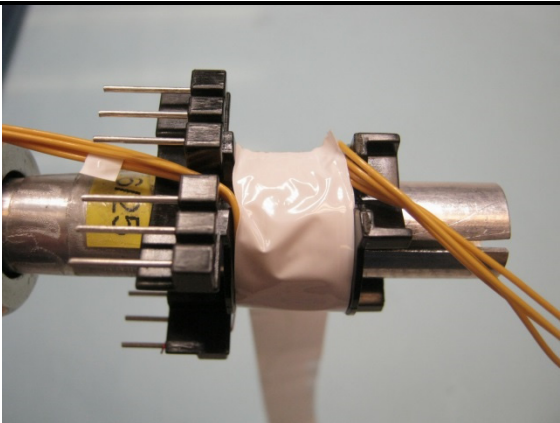
<p><b>Winding Preparation</b></p>		<p>Position the bobbin Item [2] on the mandrel such that the primary side of the bobbin is on the left side. Winding direction is clockwise direction.</p>
<p><b>WD1: Primary</b></p>		<p>Start at pin 1, wind 43 turns of wire Item [3] with tight tension, from left to right, and place 1 layer of tape Item [7]. Continue wind another 40T from right to left, at the last turn, terminate this wire at pin 2.</p>

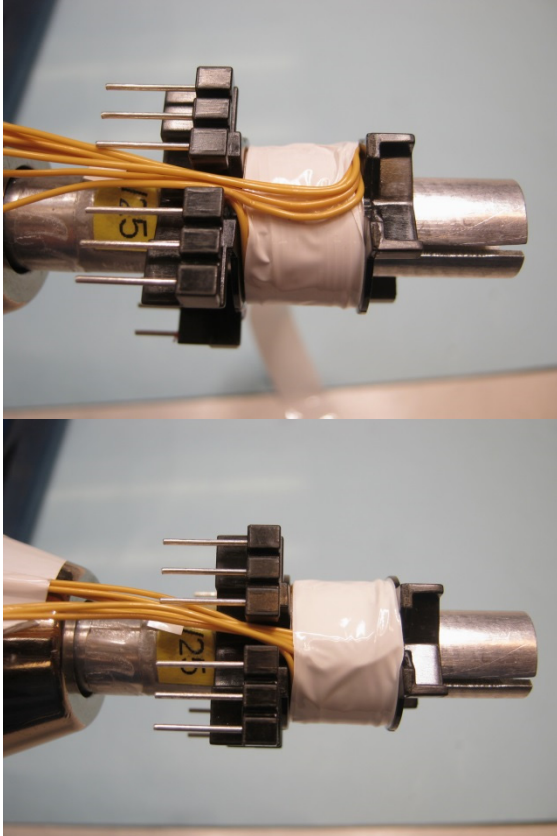
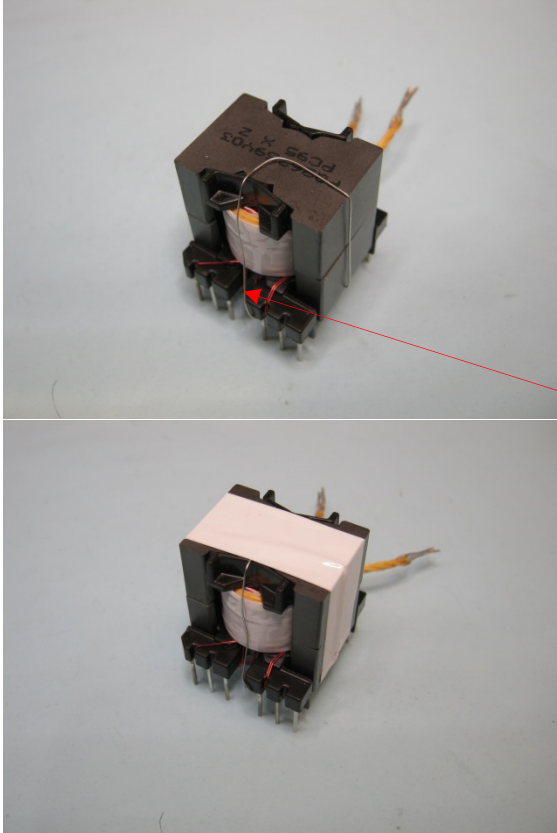
	 <p>TERMINATE at PIN 2</p>	
<p><b>Insulation</b></p>		<p>1 layer of tape Item [7].</p>

<p><b>WD2: Bias &amp; WD3: Shield</b></p>		<p>Use 2 wires Item [4] start at pin 5 for Bias winding, also use 2 wires same Item [4] start at pin 4 for Shield winding. Wind all 4 wires in parallel and together; spread the wires evenly on the bobbin. At the 4<sup>th</sup> turn:</p> <ul style="list-style-type: none"> <li>- bring 2 wires for Bias winding to the left and terminate at pin 4,</li> <li>- cut short 2 wires for Shield Winding as No-Connect.</li> </ul>
		
		

<p><b>Insulation</b></p>		<p>1 layer of tape Item [7].</p>
<p><b>WD4 Secondary</b></p>		<p>Start at left slot of secondary side of bobbin, use 2 wires Item [5] leaving ~1", mark as FL1, and wind 8 turns with tight tension. At the last turn, exit the wire at the right slot, also leaving ~2" and mark as FL2.</p>



<p><b>Insulation</b></p>		<p>Place 2 layers of tape Item [7].</p>
<p><b>WD5 Secondary</b></p>		<p>Repeat same winding above and on top, also start as FL1 and end FL2.</p>
<p><b>Insulation</b></p>		<p>Place 1 layer of tape Item [7], bring 4 wires floating FL2 from Secondary – WD3 to left slot and continue placing another 2 layers of tape to secure these wires and all the windings.</p>

		
<p><b>Finish</b></p>		<p>Gap core halves to get 1735uH.</p> <p>Use 2" of bus wire Item [6], solder to pin 4 then lean along core halves and secure with tape.</p> <p>Remove pins 3, 7, 8, 9, 10, 11 &amp; 12.</p> <p>Varnish with Item [8].</p>

## 7.7 Transformer Design Spreadsheet

1	DCDC_InnoSwitch3AQ1700V _Flyback_120821; Rev.2.2; Copyright Power Integrations 2021	INPUT	INFO	OUTPUT	UNITS	InnoSwitch3-AQ1700V Flyback Design Spreadsheet
2	<b>APPLICATION VARIABLES</b>					
3	VOUT	24.00		24.00	V	Output Voltage
4	<b>OPERATING CONDITION 1</b>					
5	VINDC1	1000.00		1000.00	V	Input DC voltage 1
6	IOUT1	2.500		2.500	A	Output current 1
7	POUT1			60.00	W	Output power 1
8	EFFICIENCY1			0.85		Converter efficiency for output 1
9	Z_FACTOR1			0.50		Z-factor for output 1
11	<b>OPERATING CONDITION 2</b>					
12	VINDC2	300.00		300.00	V	Input DC voltage 2
13	IOUT2	2.500		2.500	A	Output current 2
14	POUT2			60.00	W	Output power 2
15	EFFICIENCY2			0.85		Converter efficiency for output 2
16	Z_FACTOR2			0.50		Z-factor for output 2
69	<b>PRIMARY CONTROLLER SELECTION</b>					
70	ENCLOSURE			ADAPTER		Power supply enclosure
71	ILIMIT_MODE	STANDARD		STANDARD		Device current limit mode
72	VDRAIN_BREAKDOWN			1700	V	Device breakdown voltage
73	DEVICE_CODE	INN3949CQ		INN3949CQ		Device code
74	PDEVICE_MAX			70	W	Device maximum power capability
75	RDSON_25DEG			0.62	Ω	Primary switch on-time resistance at 25°C
76	RDSON_100DEG			0.98	Ω	Primary switch on-time resistance at 100°C
77	ILIMIT_MIN			1.767	A	Primary switch minimum current limit
78	ILIMIT_TYP			1.900	A	Primary switch typical current limit
79	ILIMIT_MAX			2.033	A	Primary switch maximum current limit
80	VDRAIN_ON_PRSW			0.21	V	Primary switch on-time voltage drop
81	VDRAIN_OFF_PRSW			1290	V	Peak drain voltage on the primary switch during turn-off
85	<b>WORST CASE ELECTRICAL PARAMETERS</b>					
86	FSWITCHING_MAX	36500		36500	Hz	Maximum switching frequency at full load and the valley of the minimum input AC voltage
87	VOR	250.0		250.0	V	Voltage reflected to the primary winding (corresponding to set-point 1) when the primary switch turns off
88	KP			1.932		Measure of continuous/discontinuous mode of operation
89	MODE_OPERATION			DCM		Mode of operation
90	DUTYCYCLE			0.302		Primary switch duty cycle
91	TIME_ON_MIN			2.43	us	Minimum primary switch on-time
92	TIME_ON_MAX			9.50	us	Maximum Primary switch on-time
93	TIME_OFF			19.30	us	Primary switch off-time



94	LPRIMARY_MIN			1647.9	uH	Minimum primary magnetizing inductance
95	LPRIMARY_TYP			1734.6	uH	Typical primary magnetizing inductance
96	LPRIMARY_TOL			5.0	%	Primary magnetizing inductance tolerance
97	LPRIMARY_MAX			1821.3	uH	Maximum primary magnetizing inductance
<b>99</b>	<b>PRIMARY CURRENT</b>					
100	IAVG_PRIMARY			1.600	A	Primary switch average current
101	IPEAK_PRIMARY			1.600	A	Primary switch peak current
102	IPEDESTAL_PRIMARY			0.218	A	Primary switch current pedestal
103	IRIPPLE_PRIMARY			1.600	A	Primary switch ripple current
104	IRMS_PRIMARY			0.482	A	Primary switch RMS current
<b>106</b>	<b>SECONDARY CURRENT</b>					
107	IPEAK_SECONDARY			16.599	A	Secondary winding peak current
108	IPEDESTAL_SECONDARY			0.000	A	Secondary winding pedestal current
109	IRMS_SECONDARY			5.476	A	Secondary winding RMS current
110	IRIPPLE_CAP_OUT			4.872	A	Output capacitor ripple current
<b>113</b>	<b>TRANSFORMER CONSTRUCTION PARAMETERS</b>					
<b>114</b>	<b>CORE SELECTION</b>					
115	CORE	PQ26/25		PQ26/25		Core selection
116	CORE NAME			B65877A000 0R095		Core code
117	AE			122.0	mm <sup>2</sup>	Core cross sectional area
118	LE			53.6	mm	Core magnetic path length
119	AL			5700	nH	Ungapped core effective inductance per turns squared
120	VE			6530	mm <sup>3</sup>	Core volume
121	BOBBIN NAME			B65878E101 2D001		Bobbin name
122	AW			47.0	mm <sup>2</sup>	Bobbin window area
123	BW			12.70	mm	Bobbin width
124	MARGIN			0.0	mm	Bobbin safety margin
<b>126</b>	<b>PRIMARY WINDING</b>					
127	NPRIMARY			83		Primary winding number of turns
128	BPEAK			3743	Gauss	Peak flux density
129	BMAX			2814	Gauss	Maximum flux density
130	BAC			1407	Gauss	AC flux density (0.5 x Peak to Peak)
131	ALG			252	nH	Typical gapped core effective inductance per turns squared
132	LG			0.582	mm	Core gap length
133	LAYERS_PRIMARY			2		Primary winding number of layers
134	AWG_PRIMARY	30		30		Primary wire gauge
135	OD_PRIMARY_INSULATED			0.303	mm	Primary wire insulated outer diameter
136	OD_PRIMARY_BARE			0.255	mm	Primary wire bare outer diameter
137	CMA_PRIMARY			208.5	Cmils/A	Primary winding wire CMA
<b>139</b>	<b>SECONDARY WINDING</b>					



140	NSECONDARY		8		8		Secondary winding number of turns
141	AWG_SECONDARY				19		Secondary wire gauge
142	OD_SECONDARY_INSULATED				1.217	mm	Secondary wire insulated outer diameter
143	OD_SECONDARY_BARE				0.912	mm	Secondary wire bare outer diameter
144	CMA_SECONDARY				235.2	Cmils/A	Secondary winding wire CMA
<b>146</b>	<b>BIAS WINDING</b>						
147	NBIAS				4		Bias winding number of turns
<b>151</b>	<b>PRIMARY COMPONENTS SELECTION</b>						
<b>152</b>	<b>BIAS WINDING</b>						
153	VBIAS				9.00	V	Rectified bias voltage
154	VF_BIAS				0.70	V	Bias winding diode forward drop
155	VREVERSE_BIASDIODE				57.19	V	Bias diode reverse voltage (not accounting parasitic voltage ring)
156	CBIAS				22	uF	Bias winding rectification capacitor
157	CBPP				0.47	uF	BPP pin capacitor
<b>161</b>	<b>SECONDARY COMPONENTS SELECTION</b>						
<b>162</b>	<b>RECTIFIER</b>						
163	VDRAIN_OFF_SRFET				144.46	V	Secondary rectifier reverse voltage (accounting for a 20% parasitic voltage ring)
164	SRFET	SQJ454EP			SQJ454EP		Secondary rectifier (Logic MOSFET)
165	VBREAKDOWN_SRFET				200	V	Secondary rectifier breakdown voltage
166	RDSON_SRFET				150.0	mΩ	SRFET on time drain resistance at 25degC for VGS=4.4V
<b>168</b>	<b>FEEDBACK COMPONENTS</b>						
169	RFB_UPPER				100.00	kΩ	Upper feedback resistor (connected to the output terminal)
170	RFB_LOWER				5.62	kΩ	Lower feedback resistor
171	CFB_LOWER				330	pF	Lower feedback resistor decoupling capacitor
<b>175</b>	<b>INPUT VOLTAGE SET-POINTS ANALYSIS</b>						
<b>176</b>	<b>TOLERANCE CORNER</b>						
177	USER_VINDC				1000	V	Input DC voltage corner to be evaluated
178	USER_ILIMIT	MAX			2.033	A	Current limit corner to be evaluated
179	USER_LPRIMARY	MAX			1821.3	uH	Primary inductance corner to be evaluated
<b>181</b>	<b>OPERATING CONDITION SELECTION</b>						
182	IOUT				2.500	A	Output current to be evaluated
183	EFFICIENCY				0.85		Converter efficiency to be evaluated
184	Z FACTOR				0.50		Z-factor to be evaluated
185	FSWITCHING				29299	Hz	Maximum switching frequency at full load
186	KP				2.745		Measure of continuous/discontinuous mode of operation
187	MODE_OPERATION				DCM		Mode of operation
188	DUTYCYCLE				0.083		Primary switch duty cycle





189	TIME_ON			2.85	us	Primary switch on-time
190	TIME_OFF			31.28	us	Primary switch off-time
<b>192</b>	<b>PRIMARY CURRENT</b>					
193	I AVG_PRIMARY			0.065	A	Primary switch average current
194	I PEAK_PRIMARY			1.564	A	Primary switch peak current
195	I PEDESTAL_PRIMARY			0.000	A	Primary switch current pedestal
196	I RIPPLE_PRIMARY			1.564	A	Primary switch ripple current
197	I RMS_PRIMARY			0.261	A	Primary switch RMS current
<b>199</b>	<b>SECONDARY CURRENT</b>					
200	I PEAK_SECONDARY			16.230	A	Secondary winding peak current
201	I PEDESTAL_SECONDARY			0.000	A	Secondary winding pedestal current
202	I RMS_SECONDARY			5.415	A	Secondary winding RMS current
203	I RIPPLE_CAP_OUT			4.803	A	Output capacitor ripple current
<b>205</b>	<b>MAGNETIC FLUX DENSITY</b>					
206	B PEAK			3743	Gauss	Peak flux density
207	B MAX			2814	Gauss	Maximum flux density
208	B AC			1407	Gauss	AC flux density (0.5 x Peak to Peak)



## 8 Performance Data

Measured at PCB output terminal.

### 8.1 Efficiency vs. Load and Input Voltage

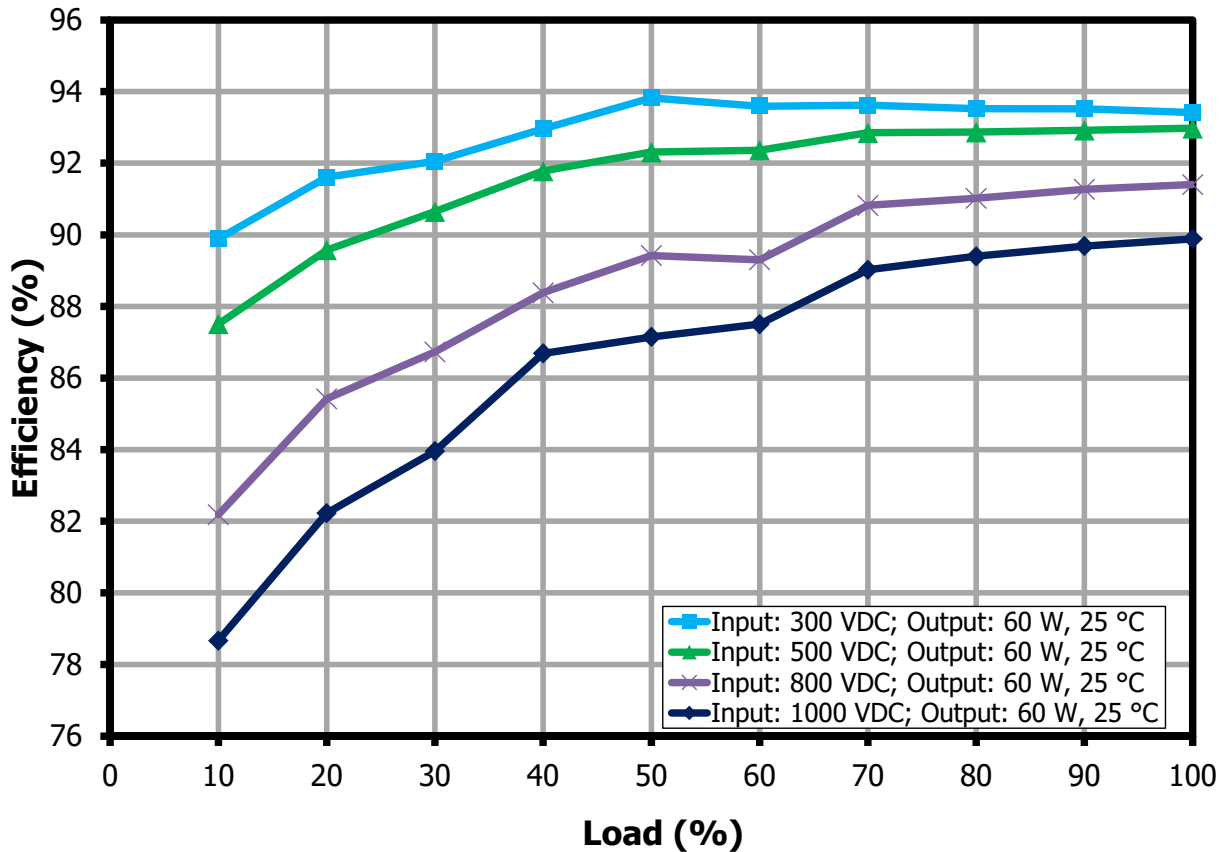


Figure 10 – Efficiency vs. Load and Input Voltage, 25 °C Ambient Temperature.

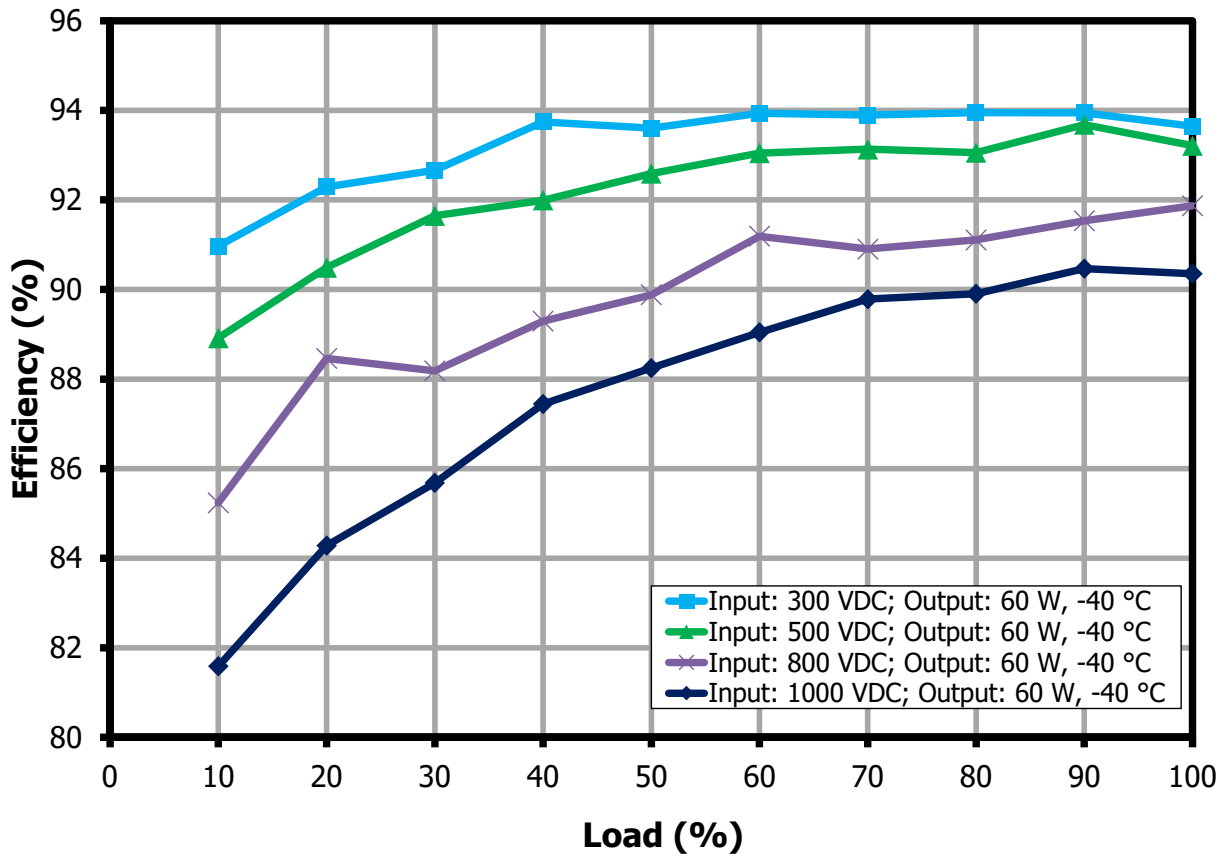


Figure 11 – Efficiency vs. Load and Input Voltage, -40 °C Ambient Temperature.

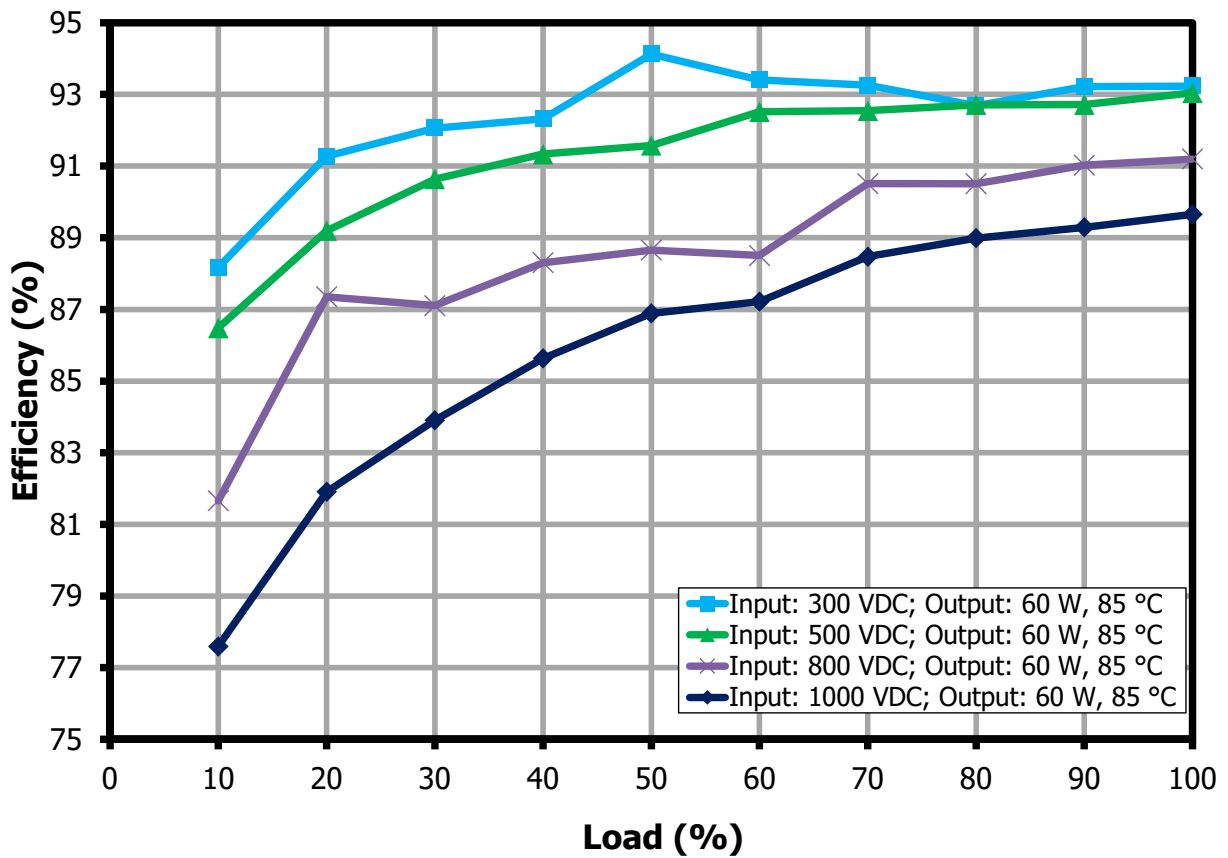


Figure 12 – Efficiency vs. Load and Input Voltage, 85 °C Ambient Temperature.

### 8.2 Full Load Efficiency vs. Line

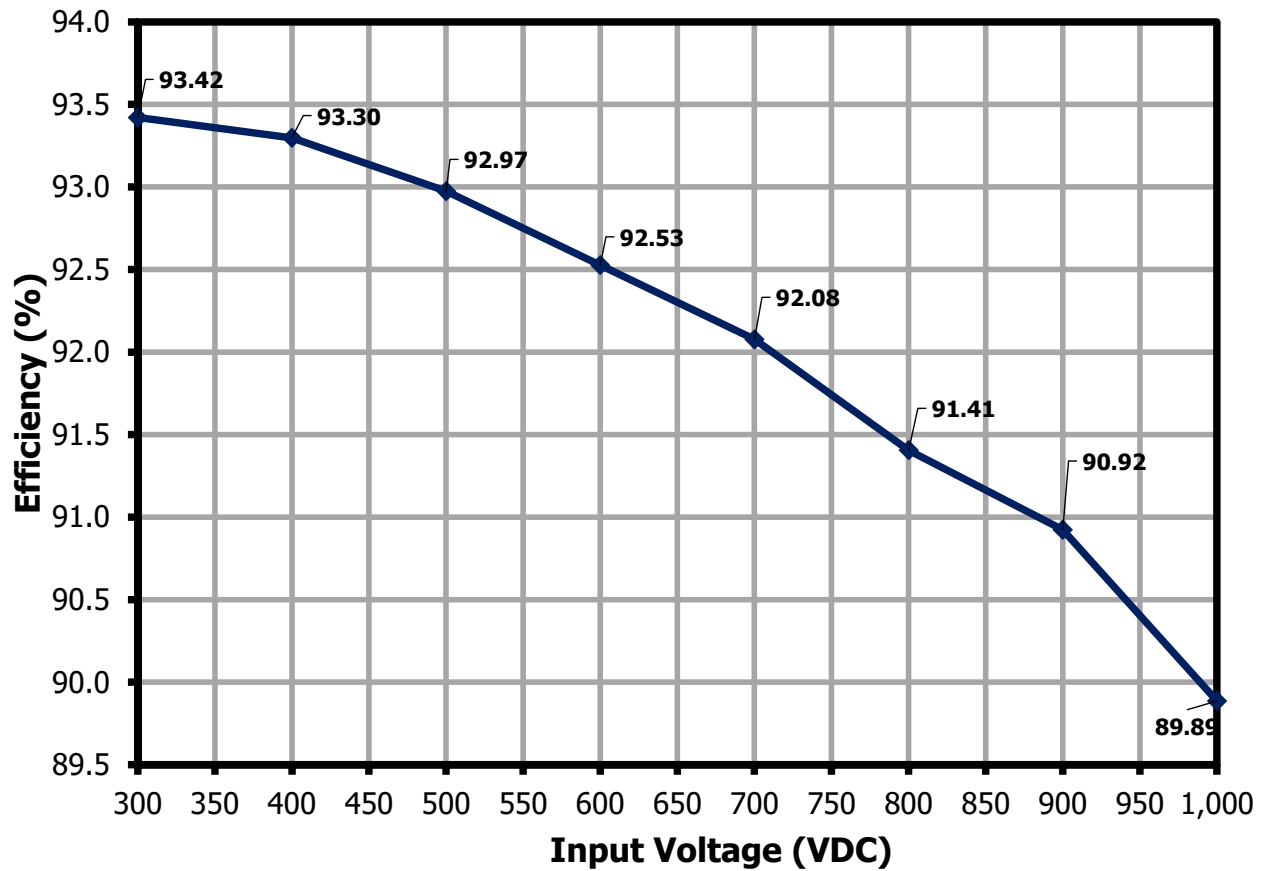


Figure 13 – Efficiency vs. Line (VDC), Room Temperature.

### 8.3 Maximum Power at Low Input Voltage

V <sub>IN</sub> (VDC)	P <sub>IN</sub> (W)	V <sub>OUT</sub> (V)	I <sub>OUT</sub> (A)	P <sub>OUT</sub> (W)	Efficiency (%)
50	4.73	23.41	0.18	4.20	88.68
60	9.02	23.04	0.36	8.25	91.48
70	27.74	23.10	1.10	25.29	91.18
80	31.06	23.18	1.23	28.51	91.79
90	34.01	23.25	1.35	31.39	92.29
100	36.97	23.30	1.47	34.25	92.64
200	50.1	23.53	2.00	47.06	93.92

### 8.4 No-Load Input Power

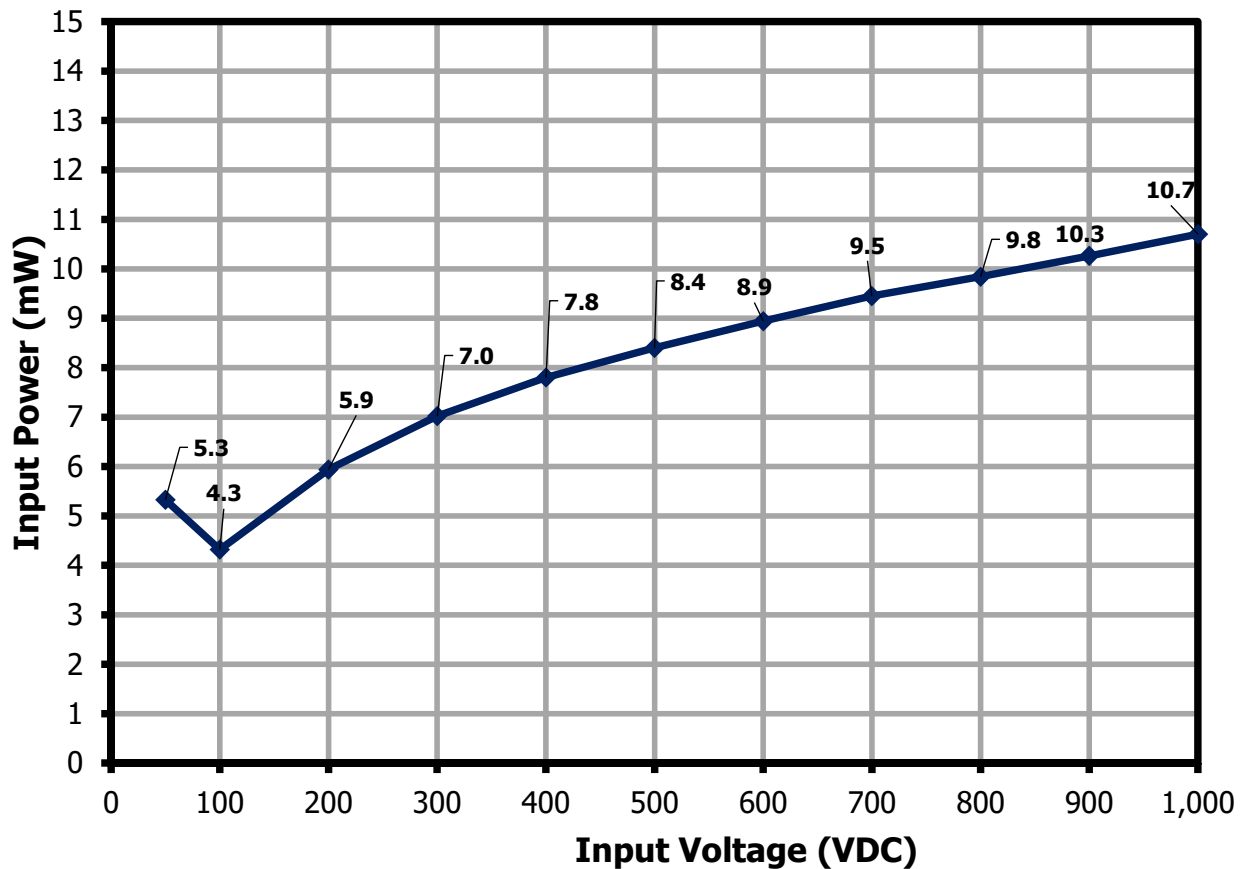
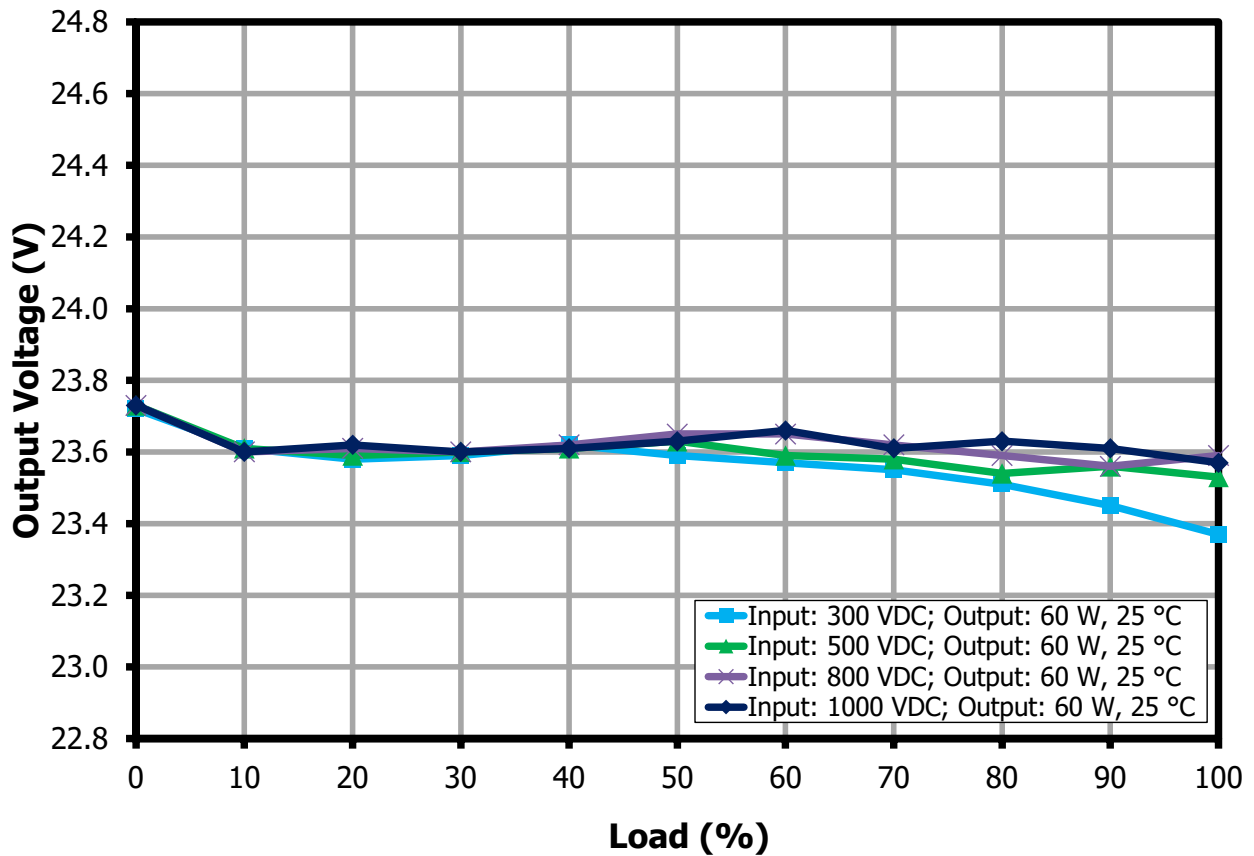


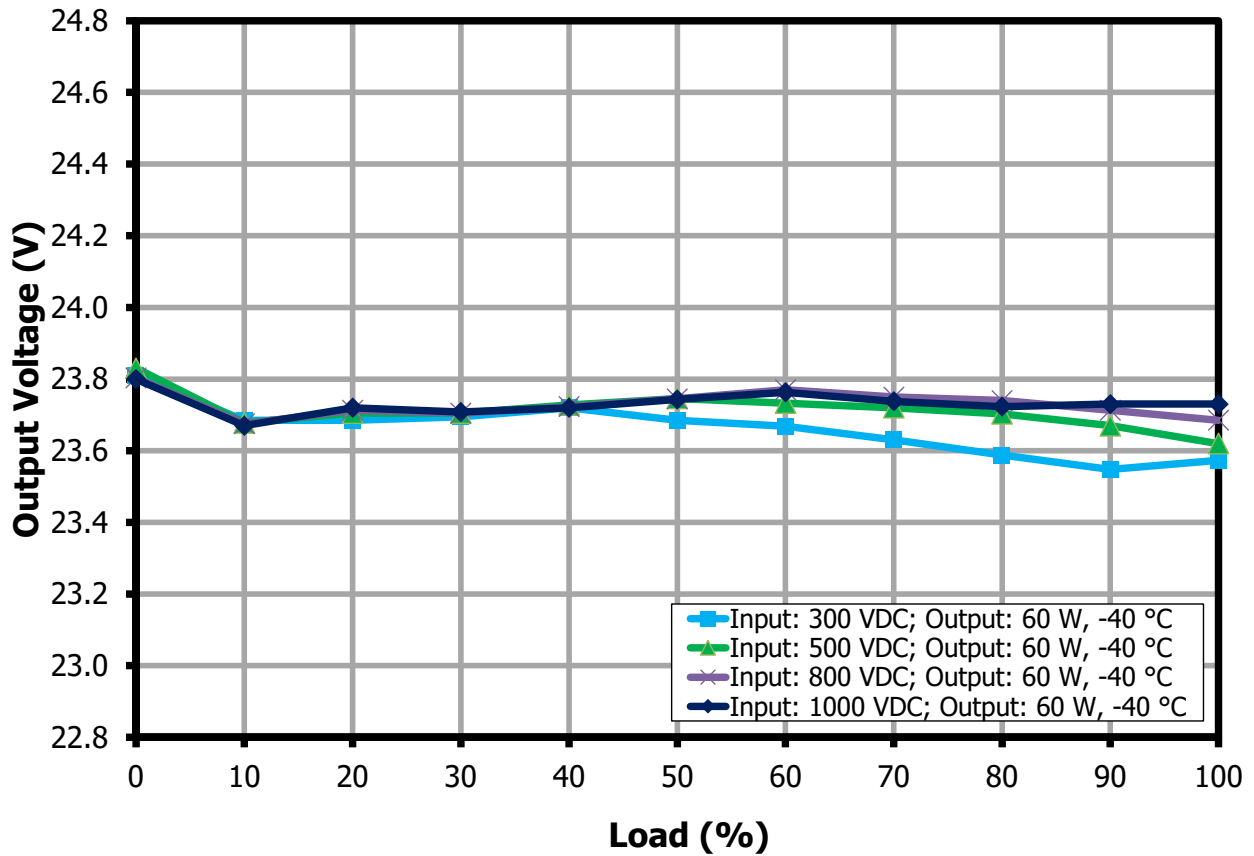
Figure 14 – No-Load Input Power, Room Temperature.

## 8.5 Load and Line Regulation

Measurements taken at 0% to 100% of rated load



**Figure 15** – Output Voltage vs. Output Current and Input Voltage (VDC), 25 °C Ambient Temperature.



**Figure 16** – Output Voltage vs. Output Current and Input Voltage (VDC), -40 °C Ambient Temperature.



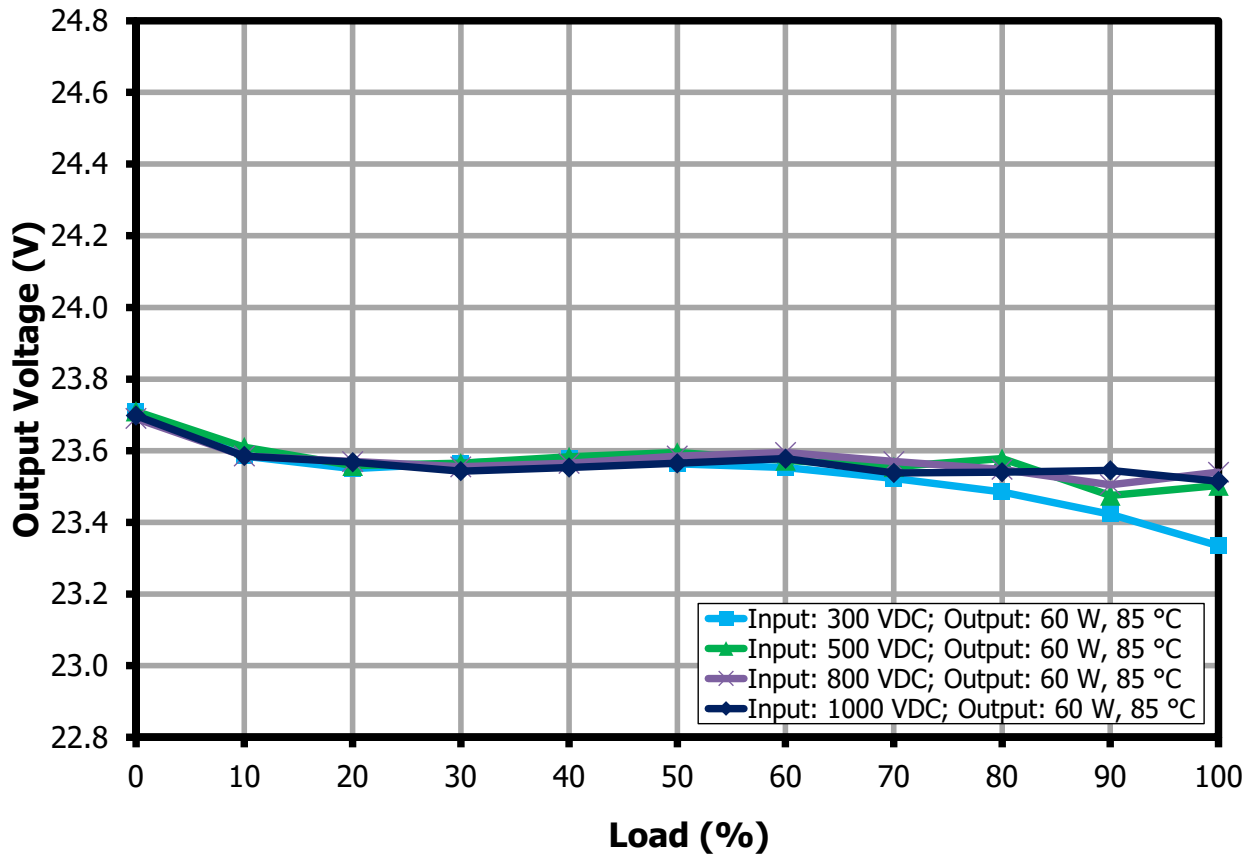
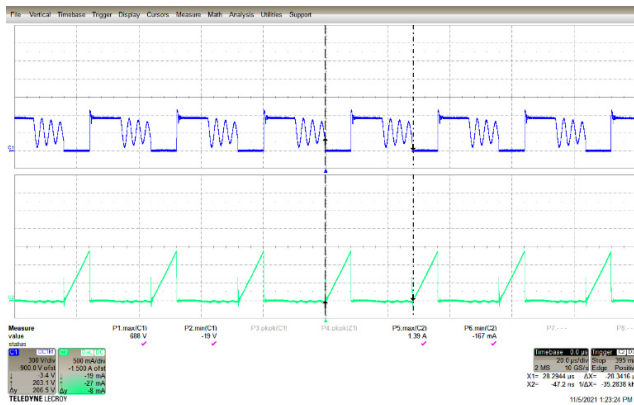


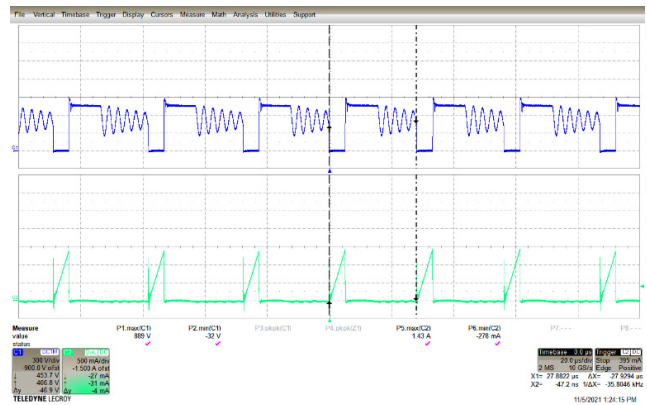
Figure 17 – Output Voltage vs. Output Current and Input Voltage (VDC), 85 °C Ambient Temperature.

## 9 Waveforms

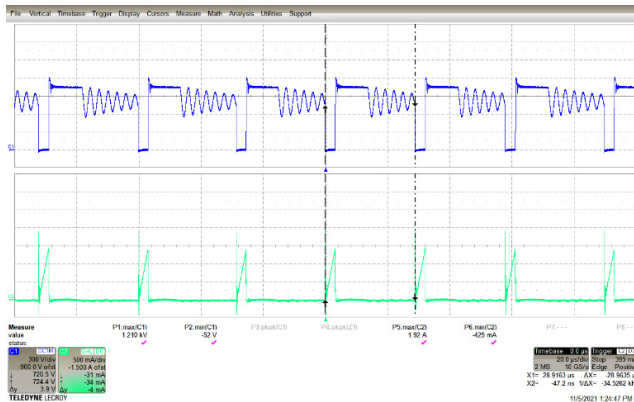
### 9.1 INN3949CQ Drain Voltage and Current, Steady-State



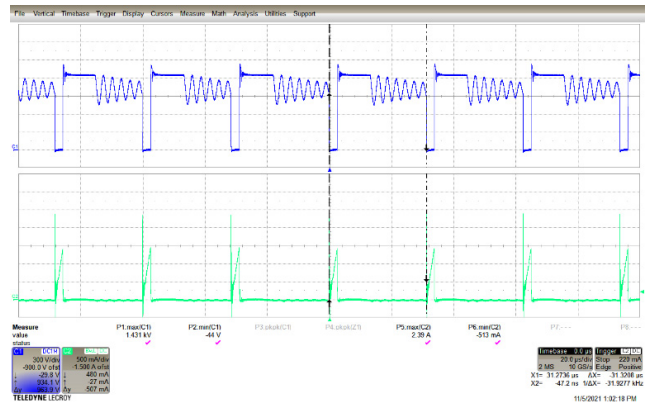
**Figure 18** – Drain Voltage and Current Waveforms.  
 $V_{IN} = 300 \text{ VDC}$ ,  $I_{OUT} = 2.5 \text{ A}$ .  
 $V_{DS(MAX)} = 688 \text{ V}$ .  
 $I_{DS(MAX)} = 1.39 \text{ A}$ .  
 Upper:  $V_{DRAIN}$ , 300 V, 20  $\mu\text{s}$  / div.  
 Lower:  $I_{DRAIN}$ , 500 mA, 20  $\mu\text{s}$  / div.



**Figure 19** – Drain Voltage and Current Waveforms.  
 $V_{IN} = 500 \text{ VDC}$ ,  $I_{OUT} = 2.5 \text{ A}$ .  
 $V_{DS(MAX)} = 889 \text{ V}$ .  
 $I_{DS(MAX)} = 1.43 \text{ A}$ .  
 Upper:  $V_{DRAIN}$ , 300 V, 20  $\mu\text{s}$  / div.  
 Lower:  $I_{DRAIN}$ , 500 mA, 20  $\mu\text{s}$  / div.

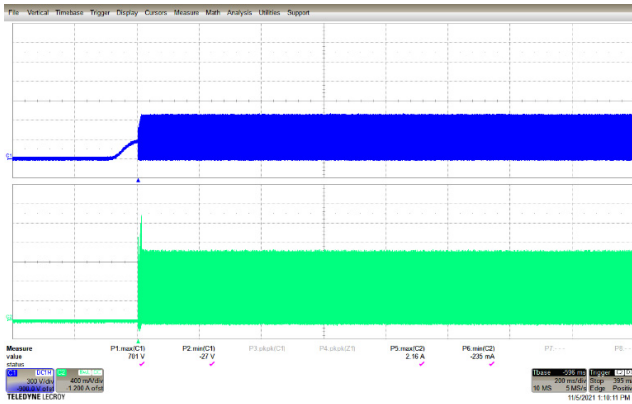


**Figure 20** – Drain Voltage and Current Waveforms.  
 $V_{IN} = 800 \text{ VDC}$ ,  $I_{OUT} = 2.5 \text{ A}$ .  
 $V_{DS(MAX)} = 1210 \text{ V}$ .  
 $I_{DS(MAX)} = 1.92 \text{ A}$ .  
 Upper:  $V_{DRAIN}$ , 300 V, 20  $\mu\text{s}$  / div.  
 Lower:  $I_{DRAIN}$ , 500 mA, 20  $\mu\text{s}$  / div.

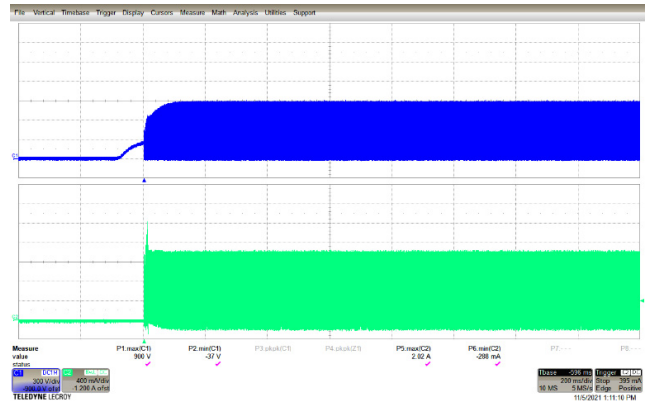


**Figure 21** – Drain Voltage and Current Waveforms.  
 $V_{IN} = 1000 \text{ VDC}$ ,  $I_{OUT} = 2.5 \text{ A}$ .  
 $V_{DS(MAX)} = 1431 \text{ V}$ .  
 $I_{DS(MAX)} = 2.39 \text{ A}$ .  
 Upper:  $V_{DRAIN}$ , 300 V, 20  $\mu\text{s}$  / div.  
 Lower:  $I_{DRAIN}$ , 500 mA, 20  $\mu\text{s}$  / div.

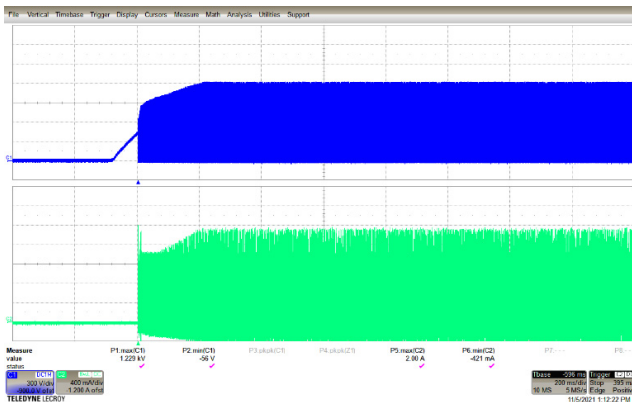
## 9.2 *INN3949CQ Drain Voltage and Current, Start-up*



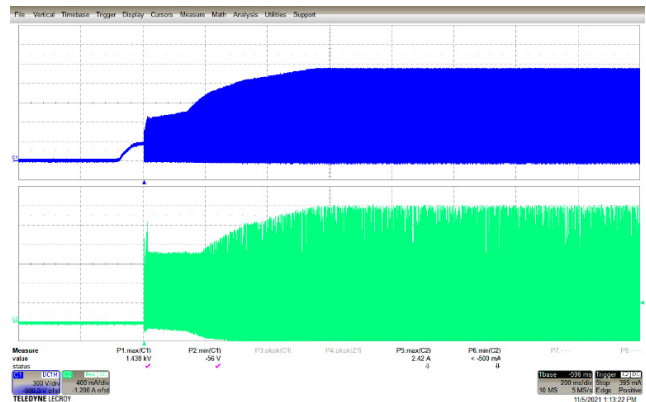
**Figure 22** – Drain Voltage and Current Waveforms.  
 $V_{IN} = 300 \text{ VDC}$ ,  $I_{OUT} = 2.5 \text{ A}$ .  
 $V_{DS(MAX)} = 701 \text{ V}$ .  
 $I_{DS(MAX)} = 2.16 \text{ A}$ .  
 Upper:  $V_{DRAIN}$ , 300 V, 200 ms / div.  
 Lower:  $I_{DRAIN}$ , 400 mA, 200 ms / div.



**Figure 23** – Drain Voltage and Current Waveforms.  
 $V_{IN} = 500 \text{ VDC}$ ,  $I_{OUT} = 2.5 \text{ A}$ .  
 $V_{DS(MAX)} = 900 \text{ V}$ .  
 $I_{DS(MAX)} = 2.02 \text{ A}$ .  
 Upper:  $V_{DRAIN}$ , 300 V, 200 ms / div.  
 Lower:  $I_{DRAIN}$ , 400 mA, 200 ms / div.

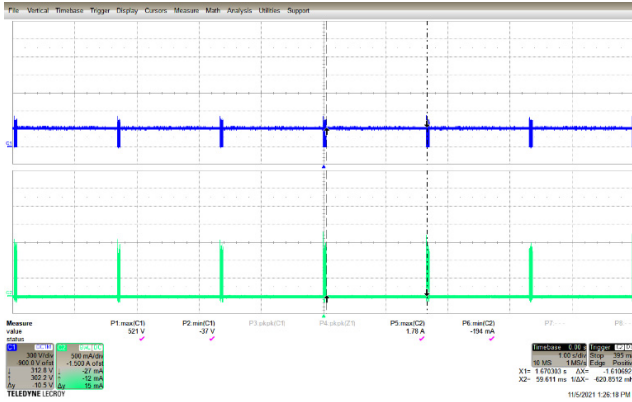


**Figure 24** – Drain Voltage and Current Waveforms.  
 $V_{IN} = 800 \text{ VDC}$ ,  $I_{OUT} = 2.5 \text{ A}$ .  
 $V_{DS(MAX)} = 1229 \text{ V}$ .  
 $I_{DS(MAX)} = 2.00 \text{ A}$ .  
 Upper:  $V_{DRAIN}$ , 300 V, 200 ms / div.  
 Lower:  $I_{DRAIN}$ , 400 mA, 200 ms / div.

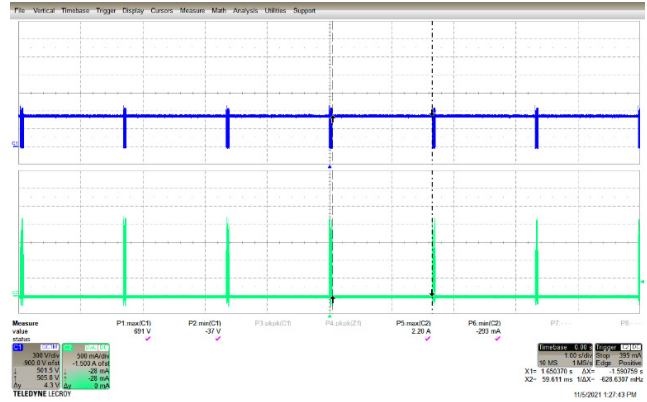


**Figure 25** – Drain Voltage and Current Waveforms.  
 $V_{IN} = 1000 \text{ VDC}$ ,  $I_{OUT} = 2.5 \text{ A}$ .  
 $V_{DS(MAX)} = 1438 \text{ V}$ .  
 $I_{DS(MAX)} = 2.42 \text{ A}$ .  
 Upper:  $V_{DRAIN}$ , 300 V, 200 ms / div.  
 Lower:  $I_{DRAIN}$ , 400 mA, 200 ms / div.

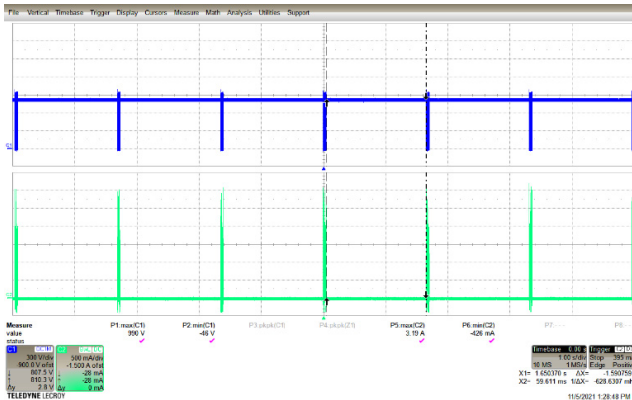
### 9.3 *INN3949CQ Drain Voltage and Current, Output Shorted*



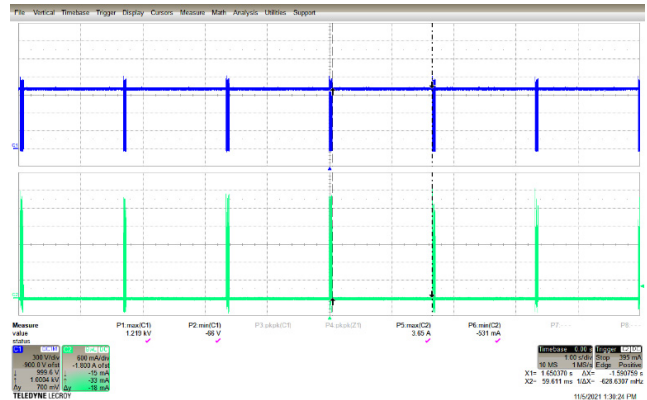
**Figure 26** – Drain Voltage and Current Waveforms.  
 $V_{IN} = 300 \text{ VDC}$ ,  $I_{OUT} = \text{Output Shorted}$ .  
 $V_{DS(\text{MAX})} = 521 \text{ V}$ .  
 $I_{DS(\text{MAX})} = 1.78 \text{ A}$ .  
 Upper:  $V_{\text{DRAIN}}$ , 300 V, 1 s / div.  
 Lower:  $I_{\text{DRAIN}}$ , 500 mA, 1 s / div.



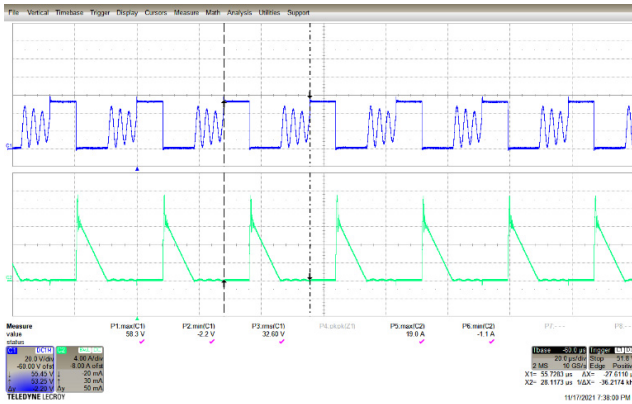
**Figure 27** – Drain Voltage and Current Waveforms.  
 $V_{IN} = 500 \text{ VDC}$ ,  $I_{OUT} = \text{Output Shorted}$ .  
 $V_{DS(\text{MAX})} = 691 \text{ V}$ .  
 $I_{DS(\text{MAX})} = 2.20 \text{ A}$ .  
 Upper:  $V_{\text{DRAIN}}$ , 300 V, 1 s / div.  
 Lower:  $I_{\text{DRAIN}}$ , 500 mA, 1 s / div.



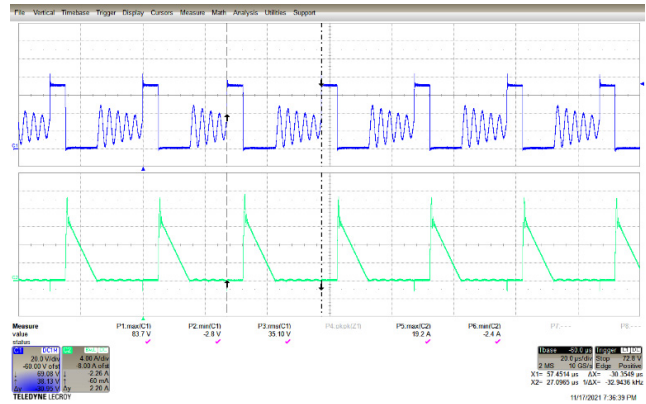
**Figure 28** – Drain Voltage and Current Waveforms.  
 $V_{IN} = 800 \text{ VDC}$ ,  $I_{OUT} = \text{Output Shorted}$ .  
 $V_{DS(\text{MAX})} = 990 \text{ V}$ .  
 $I_{DS(\text{MAX})} = 3.19 \text{ A}$ .  
 Upper:  $V_{\text{DRAIN}}$ , 300 V, 1 s / div.  
 Lower:  $I_{\text{DRAIN}}$ , 500 mA, 1 s / div.



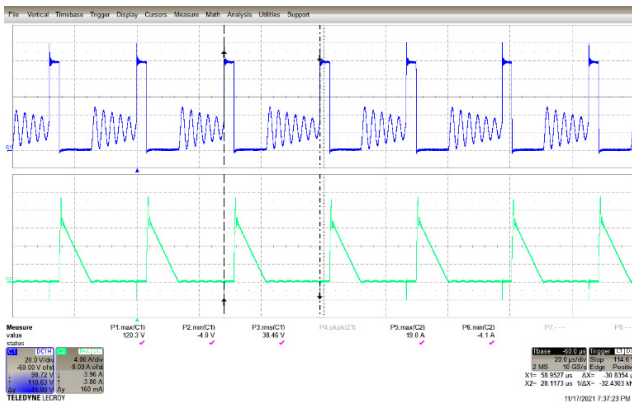
**Figure 29** – Drain Voltage and Current Waveforms.  
 $V_{IN} = 1000 \text{ VDC}$ ,  $I_{OUT} = \text{Output Shorted}$ .  
 $V_{DS(\text{MAX})} = 1219 \text{ V}$ .  
 $I_{DS(\text{MAX})} = 3.65 \text{ A}$ .  
 Upper:  $V_{\text{DRAIN}}$ , 300 V, 1 s / div.  
 Lower:  $I_{\text{DRAIN}}$ , 500 mA, 1 s / div.

9.4 **SR FET Waveforms, Steady-State**

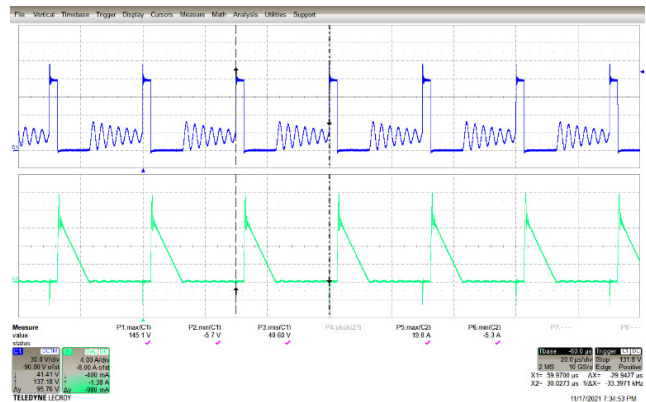
**Figure 30** – SRFET Drain Voltage and Current Waveforms.  
 $V_{IN} = 300 \text{ VDC}$ ,  $I_{OUT} = 2.5 \text{ A}$ .  
 SRFET  $V_{DS(MAX)} = 58.3 \text{ V}$ .  
 SRFET  $I_{DS(MAX)} = 19.0 \text{ A}$ .  
 Upper: SRFET  $V_{DS}$ , 20 V, 20  $\mu\text{s}$  / div.  
 Lower: SRFET  $I_{DS}$ , 4 A, 20  $\mu\text{s}$  / div.



**Figure 31** – SRFET Drain Voltage and Current Waveforms.  
 $V_{IN} = 500 \text{ VDC}$ ,  $I_{OUT} = 2.5 \text{ A}$ .  
 SRFET  $V_{DS(MAX)} = 83.7 \text{ V}$ .  
 SRFET  $I_{DS(MAX)} = 19.2 \text{ A}$ .  
 Upper: SRFET  $V_{DS}$ , 20 V, 20  $\mu\text{s}$  / div.  
 Lower: SRFET  $I_{DS}$ , 4 A, 20  $\mu\text{s}$  / div.

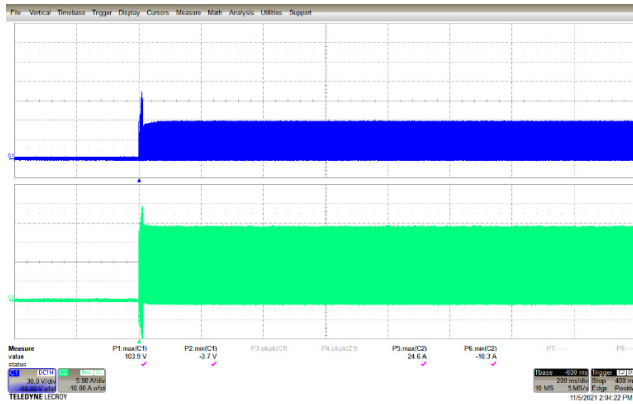


**Figure 32** – SRFET Drain Voltage and Current Waveforms.  
 $V_{IN} = 800 \text{ VDC}$ ,  $I_{OUT} = 2.5 \text{ A}$ .  
 SRFET  $V_{DS(MAX)} = 120.3 \text{ V}$ .  
 SRFET  $I_{DS(MAX)} = 19.0 \text{ A}$ .  
 Upper: SRFET  $V_{DS}$ , 20 V, 20  $\mu\text{s}$  / div.  
 Lower: SRFET  $I_{DS}$ , 4 A, 20  $\mu\text{s}$  / div.

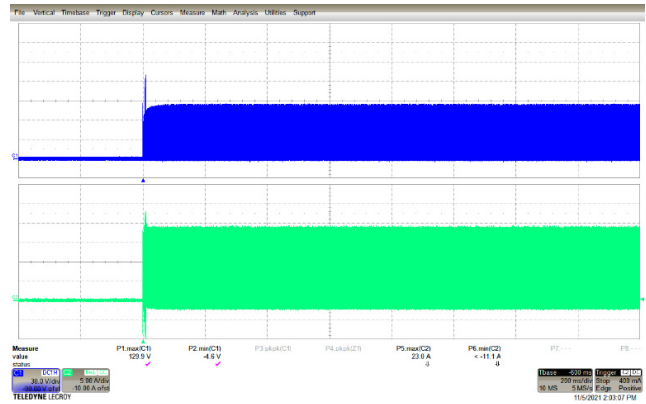


**Figure 33** – SRFET Drain Voltage and Current Waveforms.  
 $V_{IN} = 1000 \text{ VDC}$ ,  $I_{OUT} = 2.5 \text{ A}$ .  
 SRFET  $V_{DS(MAX)} = 145.1 \text{ V}$ .  
 SRFET  $I_{DS(MAX)} = 19.8 \text{ A}$ .  
 Upper: SRFET  $V_{DS}$ , 30 V, 20  $\mu\text{s}$  / div.  
 Lower: SRFET  $I_{DS}$ , 4 A, 20  $\mu\text{s}$  / div.

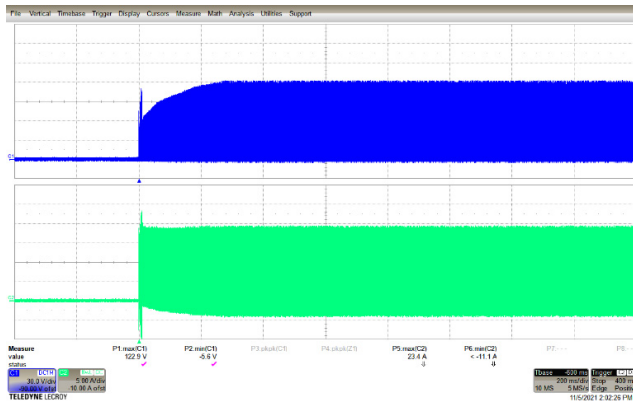
## 9.5 SR FET Waveforms, Start-up



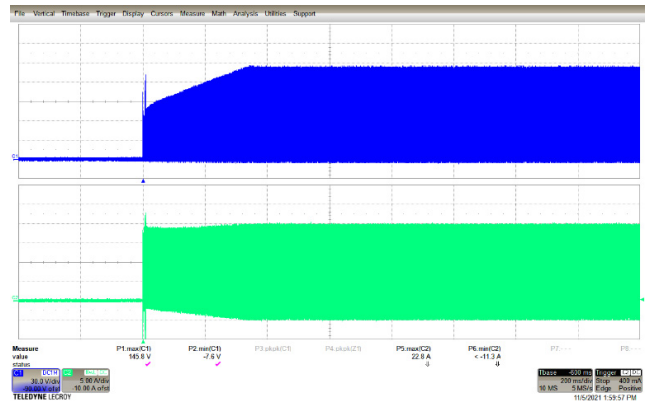
**Figure 34** – SR FET Drain Voltage and Current Waveforms.  
 $V_{IN} = 300 \text{ VDC}$ ,  $I_{OUT} = 2.5 \text{ A}$ .  
 SR FET  $V_{DS(MAX)}$  = 103.9 V.  
 SR FET  $I_{DS(MAX)}$  = 24.6 A.  
 Upper: SR FET  $V_{DS}$ , 30 V, 200 ms / div.  
 Lower: SR FET  $I_{DS}$ , 5 A, 200 ms / div.



**Figure 35** – SR FET Drain Voltage and Current Waveforms.  
 $V_{IN} = 500 \text{ VDC}$ ,  $I_{OUT} = 2.5 \text{ A}$ .  
 SR FET  $V_{DS(MAX)}$  = 129.9 V.  
 SR FET  $I_{DS(MAX)}$  = 23.0 A.  
 Upper: SR FET  $V_{DS}$ , 30 V, 200 ms / div.  
 Lower: SR FET  $I_{DS}$ , 5 A, 200 ms / div.



**Figure 36** – SR FET Drain Voltage and Current Waveforms.  
 $V_{IN} = 800 \text{ VDC}$ ,  $I_{OUT} = 2.5 \text{ A}$ .  
 SR FET  $V_{DS(MAX)}$  = 122.9 V.  
 SR FET  $I_{DS(MAX)}$  = 23.4 A.  
 Upper: SR FET  $V_{DS}$ , 30 V, 200 ms / div.  
 Lower: SR FET  $I_{DS}$ , 5 A, 200 ms / div.



**Figure 37** – SR FET Drain Voltage and Current Waveforms.  
 $V_{IN} = 1000 \text{ VDC}$ ,  $I_{OUT} = 2.5 \text{ A}$ .  
 SR FET  $V_{DS(MAX)}$  = 145.8 V.  
 SR FET  $I_{DS(MAX)}$  = 22.8 A.  
 Upper: SR FET  $V_{DS}$ , 30 V, 200 ms / div.  
 Lower: SR FET  $I_{DS}$ , 5 A, 200 ms / div.

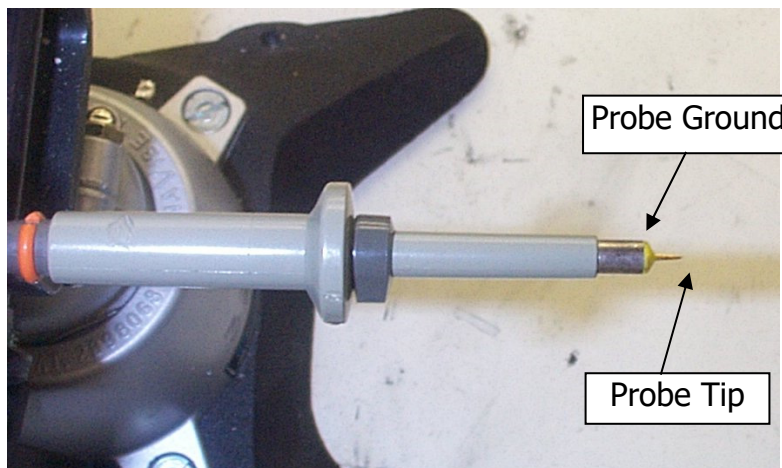




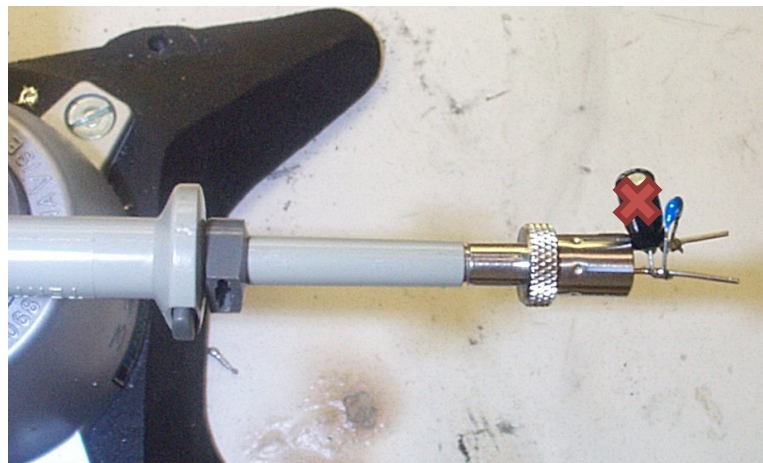
### 9.7 **Output Ripple Measurements**

For DC output ripple measurements, a modified oscilloscope test probe must be utilized to reduce spurious signals due to pick-up. Details of the probe modification are provided in the Figures below.

The 4987BA probe adapter is affixed with once capacitor tied in parallel across the probe tip. The capacitor includes one (1) 1  $\mu$ F/50 V ceramic type.



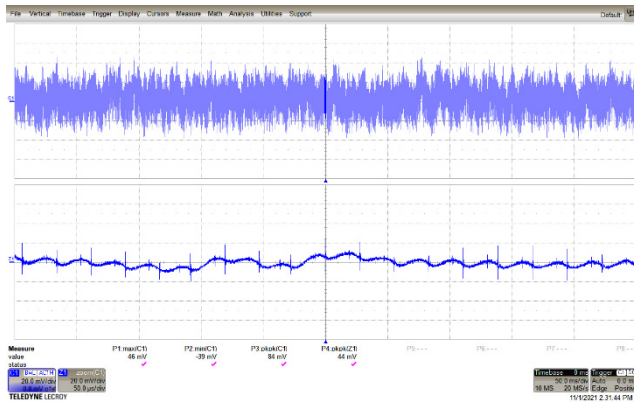
**Figure 42** – Oscilloscope Probe Prepared for Ripple Measurement. (End Cap and Ground Lead Removed.)



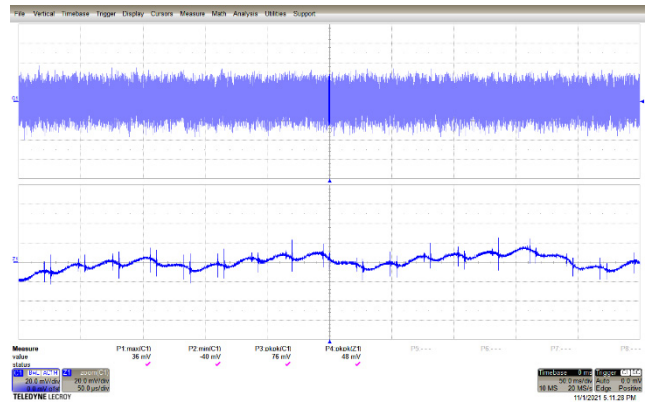
**Figure 43** – Oscilloscope Probe with Probe Master ([www.probemaster.com](http://www.probemaster.com)) 4987A BNC Adapter. (Modified with wires for ripple measurement, and one parallel decoupling capacitor added)



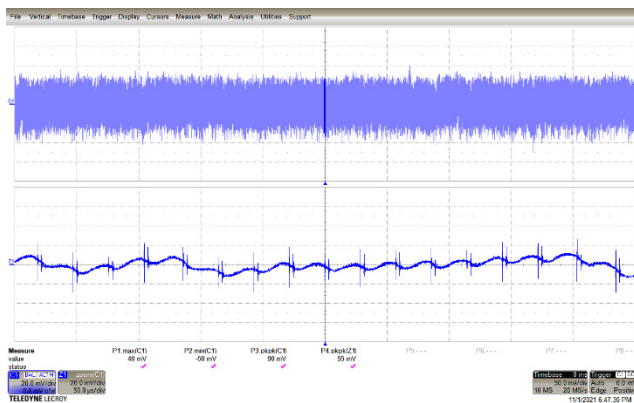
## 9.7.1 100% Loading Condition



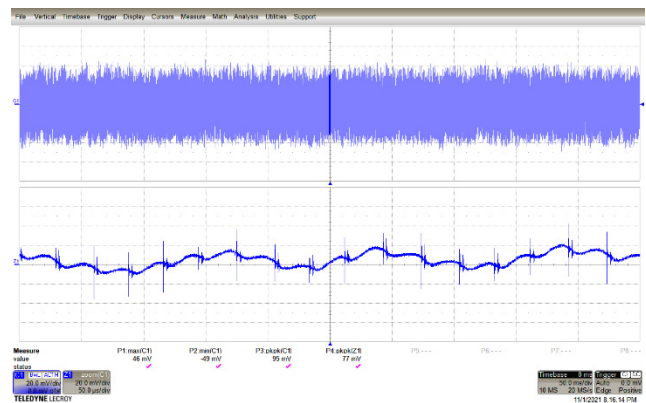
**Figure 44** – Output Voltage Ripple.  
 $V_{IN} = 300 \text{ VDC}$ ,  $I_{OUT} = 2.5 \text{ A}$ .  
 Upper:  $V_{OUT}$ , 20 mV, 50 ms / div.  
 Lower: Zoom @ 50  $\mu\text{s}$  / div.  
 $V_{RIPPLE} = 84 \text{ mV}_{P-P}$ .



**Figure 45** – Output Voltage Ripple.  
 $V_{IN} = 500 \text{ VDC}$ ,  $I_{OUT} = 2.5 \text{ A}$ .  
 Upper:  $V_{OUT}$ , 20 mV, 50 ms / div.  
 Lower: Zoom @ 50  $\mu\text{s}$  / div.  
 $V_{RIPPLE} = 76 \text{ mV}_{P-P}$ .

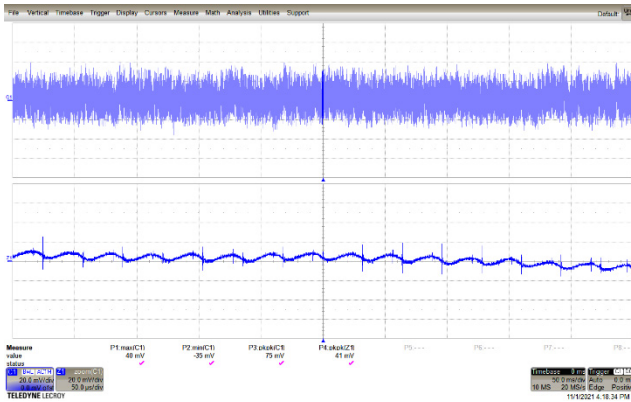


**Figure 46** – Output Voltage Ripple.  
 $V_{IN} = 800 \text{ VDC}$ ,  $I_{OUT} = 2.5 \text{ A}$ .  
 Upper:  $V_{OUT}$ , 20 mV, 50 ms / div.  
 Lower: Zoom @ 50  $\mu\text{s}$  / div.  
 $V_{RIPPLE} = 90 \text{ mV}_{P-P}$ .

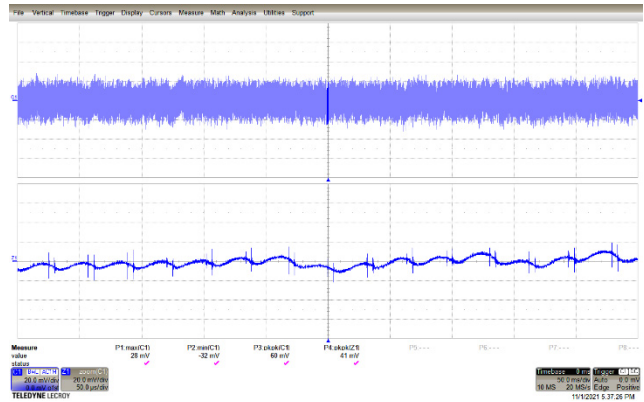


**Figure 47** – Output Voltage Ripple.  
 $V_{IN} = 1000 \text{ VDC}$ ,  $I_{OUT} = 2.5 \text{ A}$ .  
 Upper:  $V_{OUT}$ , 20 mV, 50 ms / div.  
 Lower: Zoom @ 50  $\mu\text{s}$  / div.  
 $V_{RIPPLE} = 95 \text{ mV}_{P-P}$ .

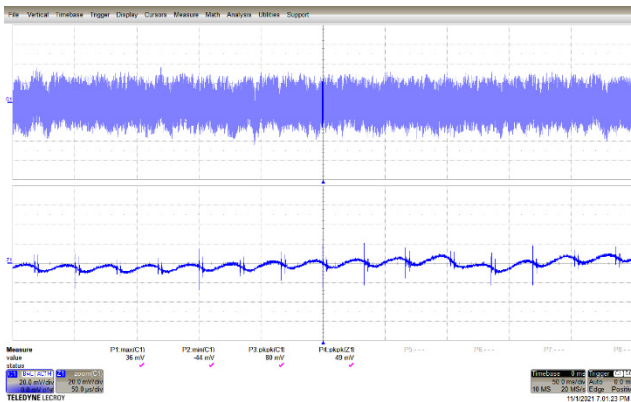
## 9.7.2 75% Loading Condition



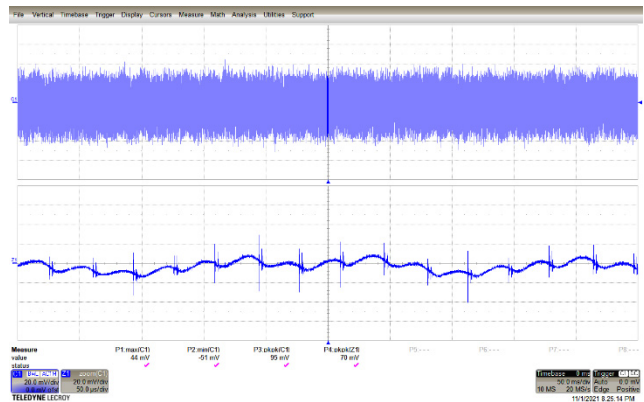
**Figure 48** – Output Voltage Ripple.  
 $V_{IN} = 300 \text{ VDC}$ ,  $I_{OUT} = 1.875 \text{ A}$ .  
 Upper:  $V_{OUT}$ , 20 mV, 50 ms / div.  
 Lower: Zoom @ 50  $\mu\text{s}$  / div.  
 $V_{RIPPLE} = 75 \text{ mV}_{P-P}$ .



**Figure 49** – Output Voltage Ripple.  
 $V_{IN} = 500 \text{ VDC}$ ,  $I_{OUT} = 1.875 \text{ A}$ .  
 Upper:  $V_{OUT}$ , 20 mV, 50 ms / div.  
 Lower: Zoom @ 50  $\mu\text{s}$  / div.  
 $V_{RIPPLE} = 60 \text{ mV}_{P-P}$ .

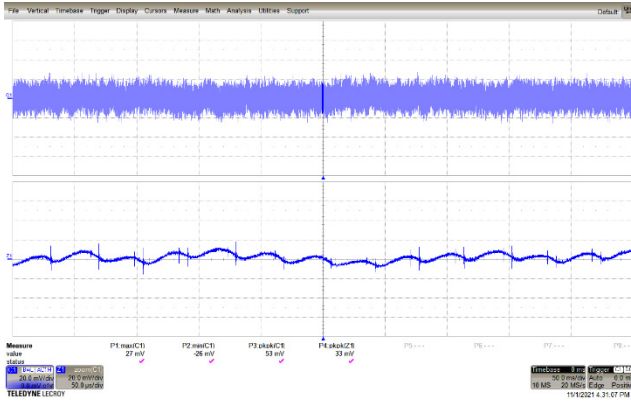


**Figure 50** – Output Voltage Ripple.  
 $V_{IN} = 800 \text{ VDC}$ ,  $I_{OUT} = 1.875 \text{ A}$ .  
 Upper:  $V_{OUT}$ , 20 mV, 50 ms / div.  
 Lower: Zoom @ 50  $\mu\text{s}$  / div.  
 $V_{RIPPLE} = 80 \text{ mV}_{P-P}$ .

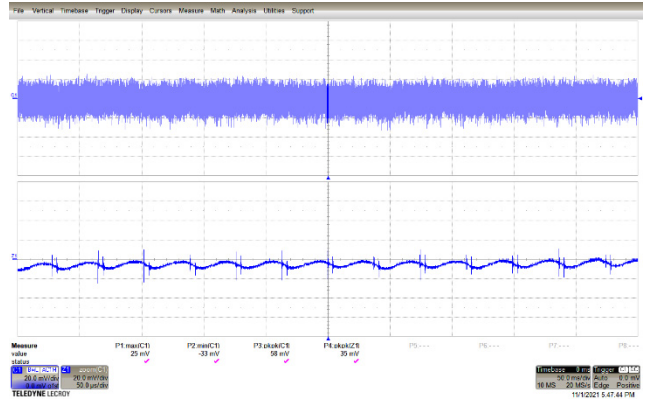


**Figure 51** – Output Voltage Ripple.  
 $V_{IN} = 1000 \text{ VDC}$ ,  $I_{OUT} = 1.875 \text{ A}$ .  
 Upper:  $V_{OUT}$ , 20 mV, 50 ms / div.  
 Lower: Zoom @ 50  $\mu\text{s}$  / div.  
 $V_{RIPPLE} = 95 \text{ mV}_{P-P}$ .

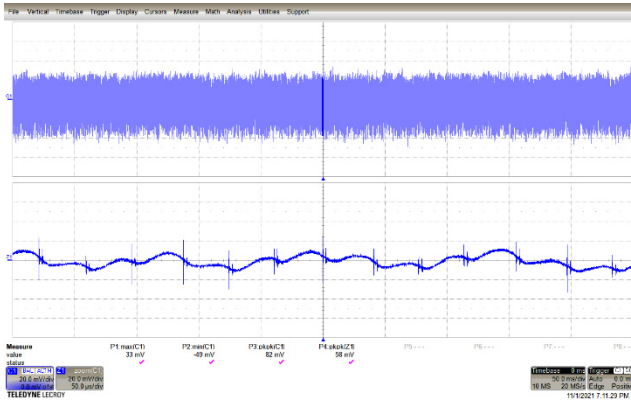
9.7.3 50% Loading Condition



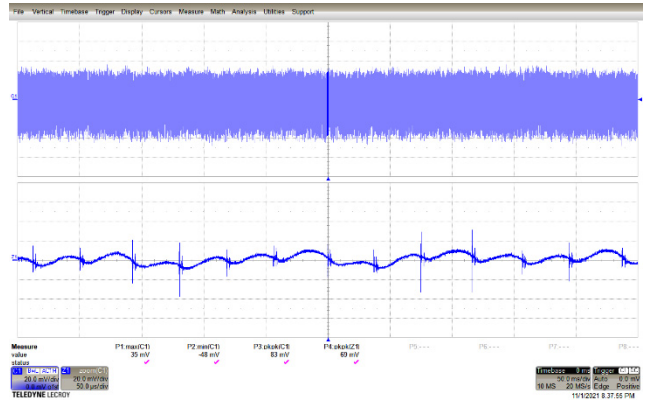
**Figure 52** – Output Voltage Ripple.  
 $V_{IN} = 300 \text{ VDC}$ ,  $I_{OUT} = 1.25 \text{ A}$ .  
 Upper:  $V_{OUT}$ , 20 mV, 50 ms / div.  
 Lower: Zoom @ 50  $\mu\text{s}$  / div.  
 $V_{RIPPLE} = 53 \text{ mV}_{P-P}$ .



**Figure 53** – Output Voltage Ripple.  
 $V_{IN} = 500 \text{ VDC}$ ,  $I_{OUT} = 1.25 \text{ A}$ .  
 Upper:  $V_{OUT}$ , 20 mV, 50 ms / div.  
 Lower: Zoom @ 50  $\mu\text{s}$  / div.  
 $V_{RIPPLE} = 58 \text{ mV}_{P-P}$ .

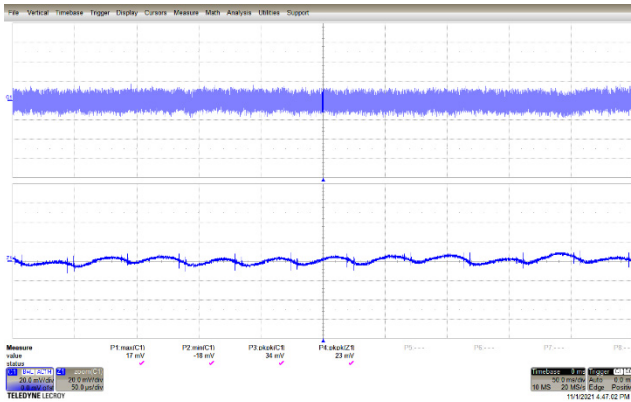


**Figure 54** – Output Voltage Ripple.  
 $V_{IN} = 800 \text{ VDC}$ ,  $I_{OUT} = 1.25 \text{ A}$ .  
 Upper:  $V_{OUT}$ , 20 mV, 50 ms / div.  
 Lower: Zoom @ 50  $\mu\text{s}$  / div.  
 $V_{RIPPLE} = 82 \text{ mV}_{P-P}$ .

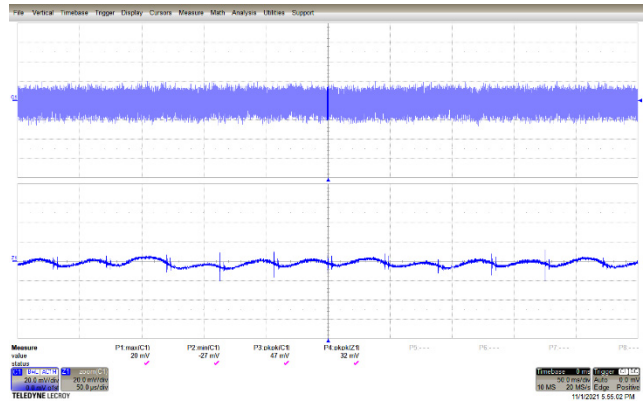


**Figure 55** – Output Voltage Ripple.  
 $V_{IN} = 1000 \text{ VDC}$ ,  $I_{OUT} = 1.25 \text{ A}$ .  
 Upper:  $V_{OUT}$ , 20 mV, 50 ms / div.  
 Lower: Zoom @ 50  $\mu\text{s}$  / div.  
 $V_{RIPPLE} = 83 \text{ mV}_{P-P}$ .

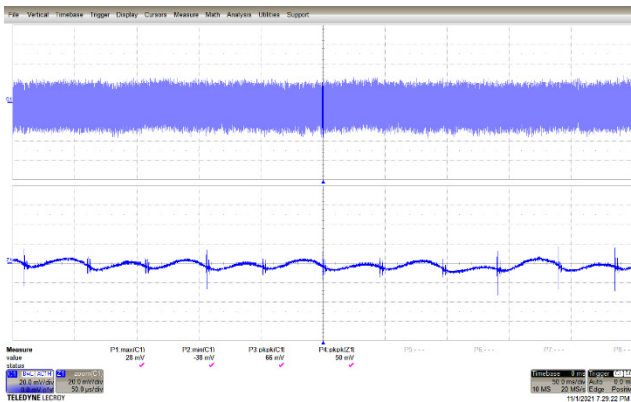
## 9.7.4 25% Loading Condition



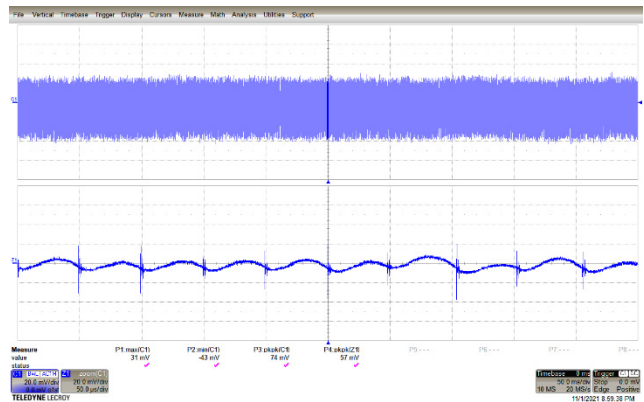
**Figure 56** – Output Voltage Ripple.  
 $V_{IN} = 300 \text{ VDC}$ ,  $I_{OUT} = 0.625 \text{ A}$ .  
 Upper:  $V_{OUT}$ , 20 mV, 50 ms / div.  
 Lower: Zoom @ 50  $\mu\text{s}$  / div.  
 $V_{RIPPLE} = 34 \text{ mV}_{P-P}$ .



**Figure 57** – Output Voltage Ripple.  
 $V_{IN} = 500 \text{ VDC}$ ,  $I_{OUT} = 0.625 \text{ A}$ .  
 Upper:  $V_{OUT}$ , 20 mV, 50 ms / div.  
 Lower: Zoom @ 50  $\mu\text{s}$  / div.  
 $V_{RIPPLE} = 47 \text{ mV}_{P-P}$ .

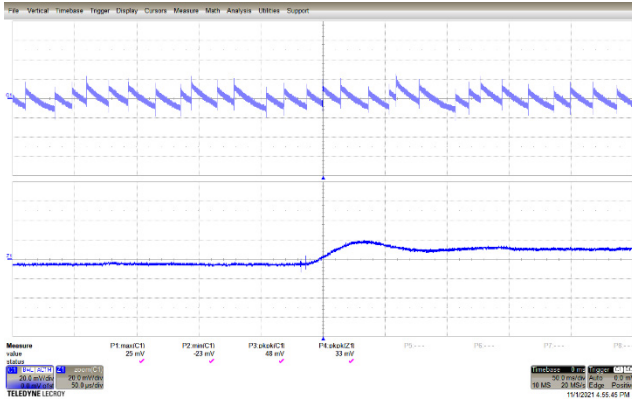


**Figure 58** – Output Voltage Ripple.  
 $V_{IN} = 800 \text{ VDC}$ ,  $I_{OUT} = 0.625 \text{ A}$ .  
 Upper:  $V_{OUT}$ , 20 mV, 50 ms / div.  
 Lower: Zoom @ 50  $\mu\text{s}$  / div.  
 $V_{RIPPLE} = 66 \text{ mV}_{P-P}$ .

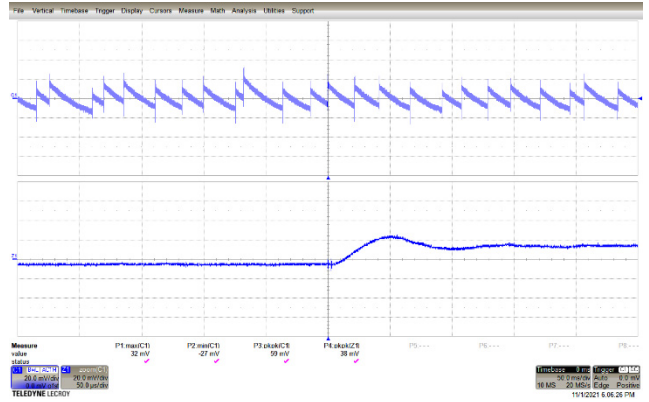


**Figure 59** – Output Voltage Ripple.  
 $V_{IN} = 1000 \text{ VDC}$ ,  $I_{OUT} = 0.625 \text{ A}$ .  
 Upper:  $V_{OUT}$ , 20 mV, 50 ms / div.  
 Lower: Zoom @ 50  $\mu\text{s}$  / div.  
 $V_{RIPPLE} = 74 \text{ mV}_{P-P}$ .

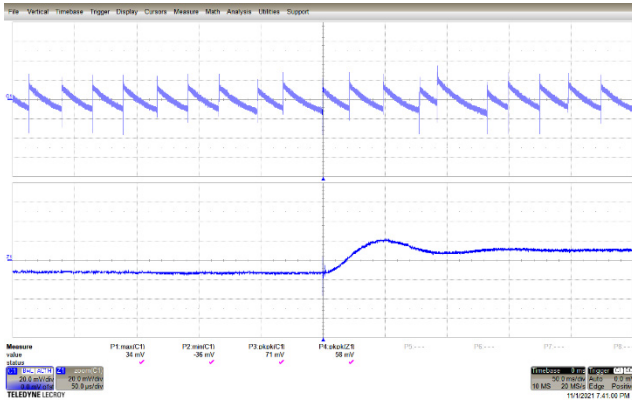
9.7.5 0% Loading Condition



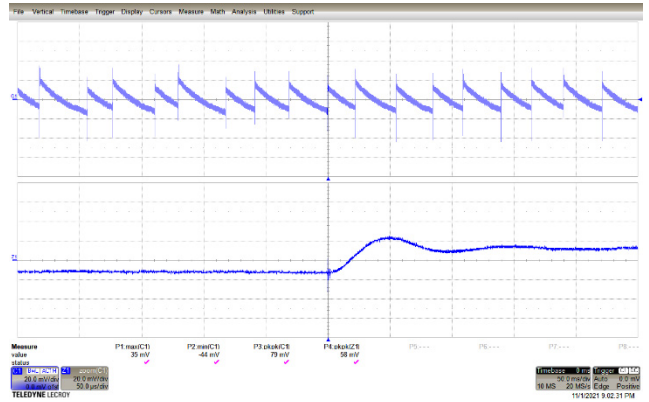
**Figure 60** – Output Voltage Ripple.  
 $V_{IN} = 300 \text{ VDC}$ ,  $I_{OUT} = 0 \text{ A}$ .  
 Upper:  $V_{OUT}$ , 20 mV, 50 ms / div.  
 Lower: Zoom @ 50  $\mu\text{s}$  / div.  
 $V_{RIPPLE} = 48 \text{ mV}_{P-P}$ .



**Figure 61** – Output Voltage Ripple.  
 $V_{IN} = 500 \text{ VDC}$ ,  $I_{OUT} = 0 \text{ A}$ .  
 Upper:  $V_{OUT}$ , 20 mV, 50 ms / div.  
 Lower: Zoom @ 50  $\mu\text{s}$  / div.  
 $V_{RIPPLE} = 59 \text{ mV}_{P-P}$ .



**Figure 62** – Output Voltage Ripple.  
 $V_{IN} = 800 \text{ VDC}$ ,  $I_{OUT} = 0 \text{ A}$ .  
 Upper:  $V_{OUT}$ , 20 mV, 50 ms / div.  
 Lower: Zoom @ 50  $\mu\text{s}$  / div.  
 $V_{RIPPLE} = 71 \text{ mV}_{P-P}$ .



**Figure 63** – Output Voltage Ripple.  
 $V_{IN} = 1000 \text{ VDC}$ ,  $I_{OUT} = 0 \text{ A}$ .  
 Upper:  $V_{OUT}$ , 20 mV, 50 ms / div.  
 Lower: Zoom @ 50  $\mu\text{s}$  / div.  
 $V_{RIPPLE} = 79 \text{ mV}_{P-P}$ .

### 9.8 Output Voltage Ripple (ATE)

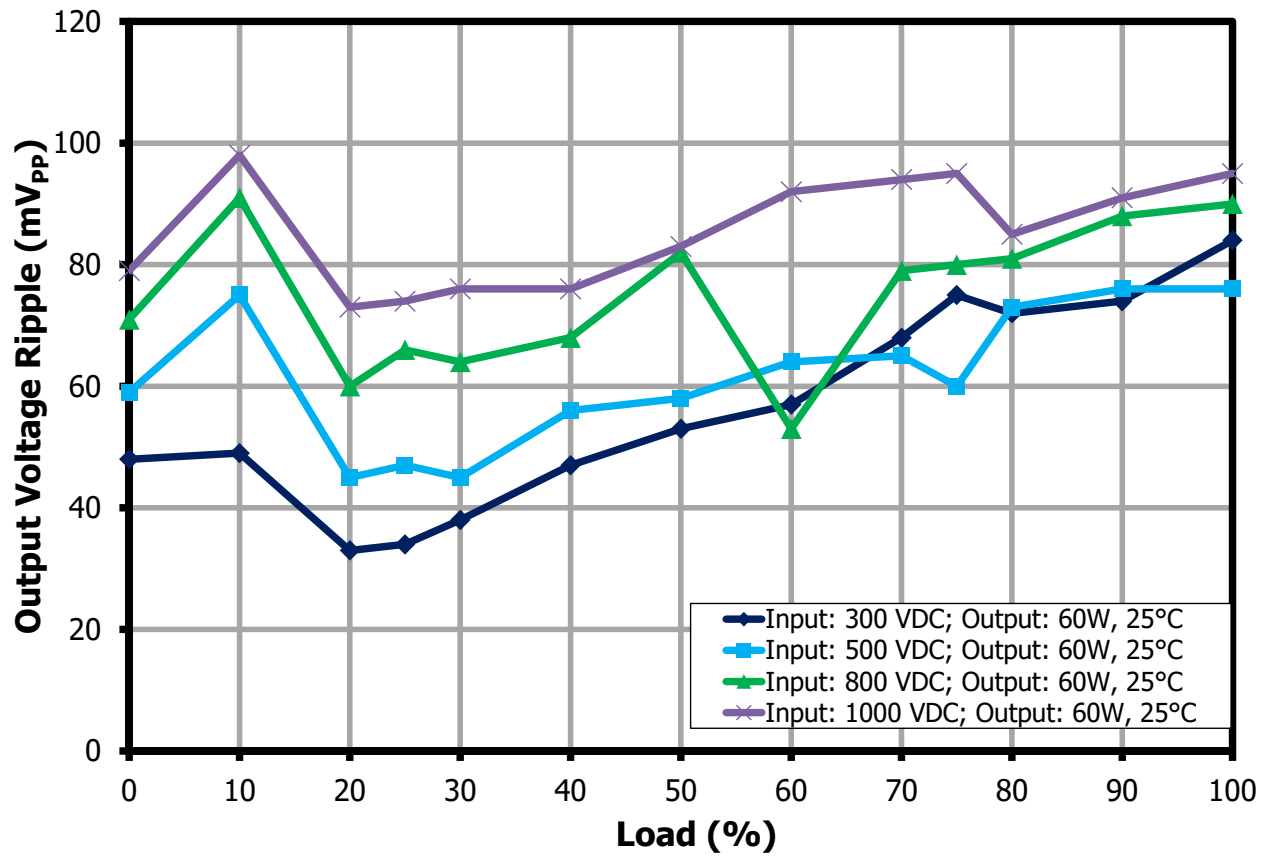


Figure 64 – Output Voltage Ripple, 25 °C Ambient Temperature.

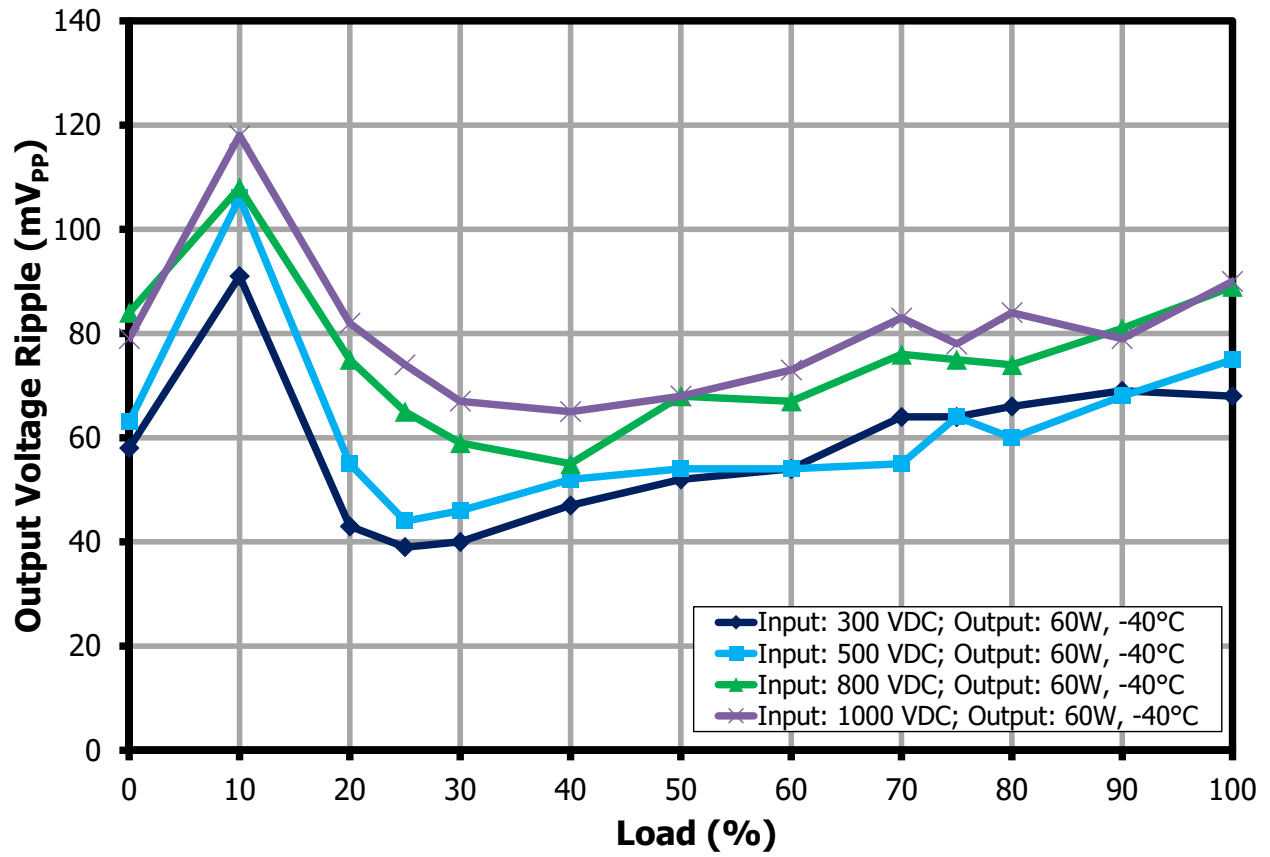


Figure 65 – Output Voltage Ripple, -40 °C Ambient Temperature.

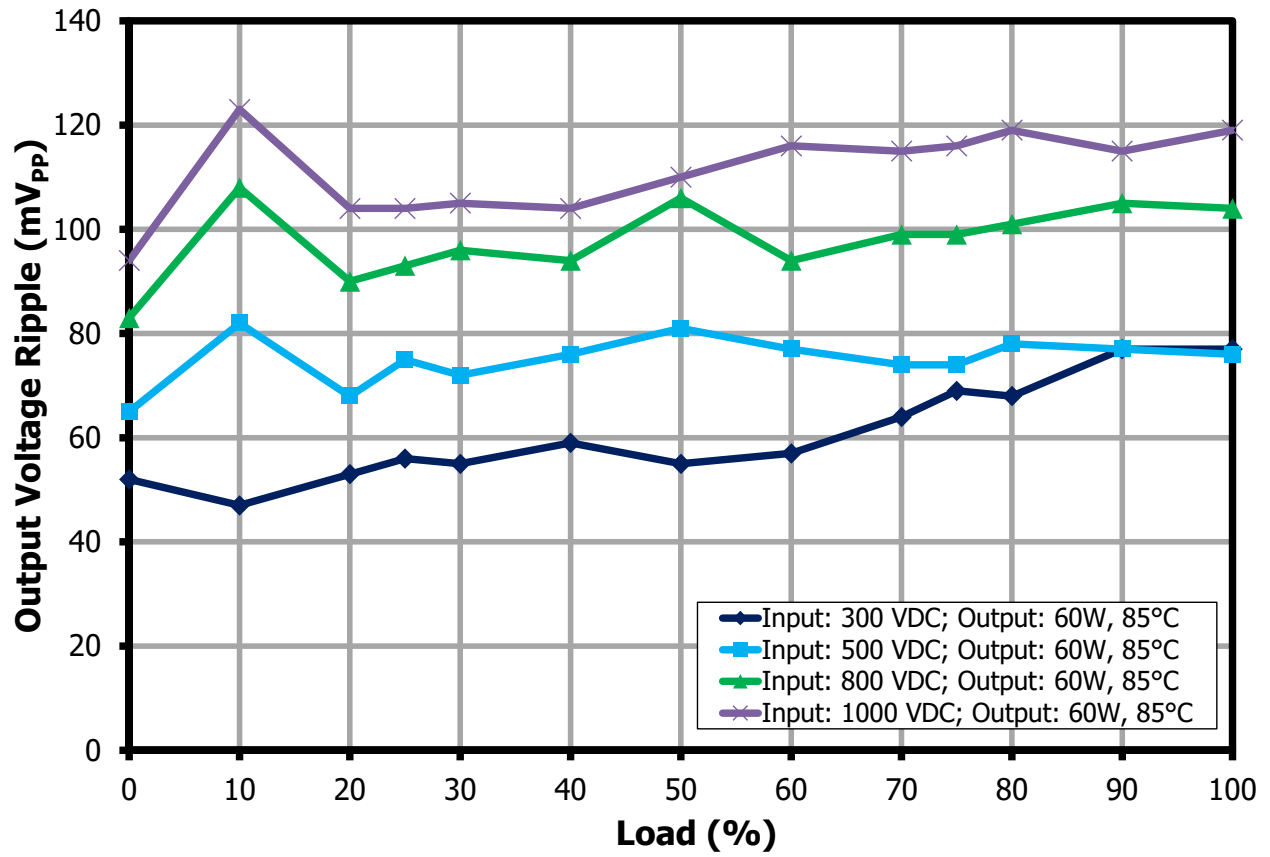
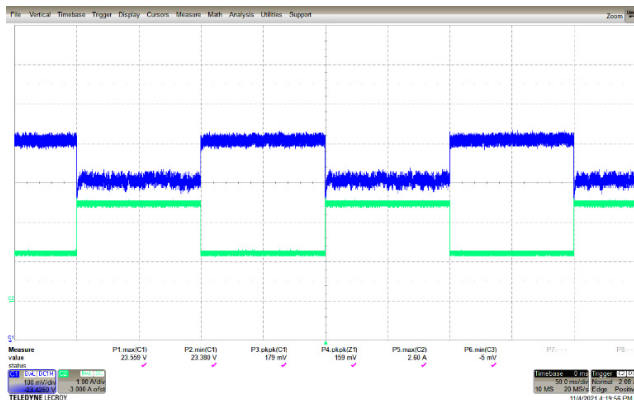


Figure 66 – Output Voltage Ripple, 85 °C Ambient Temperature.

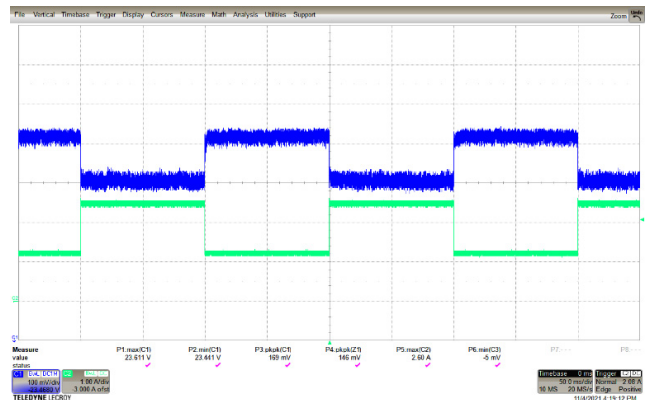


## 9.9 Output Load Transient

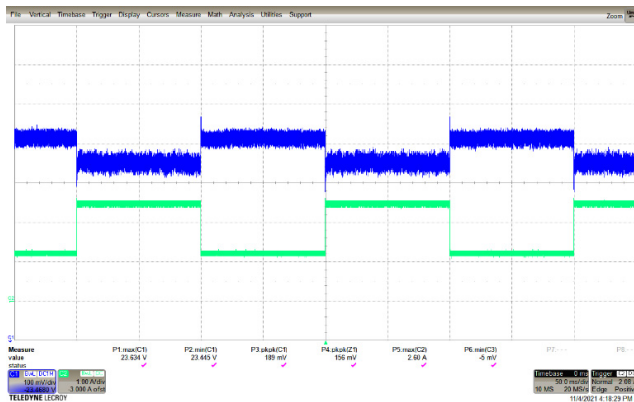
### 9.9.1 Output Load Transient, 100% to 50% Load



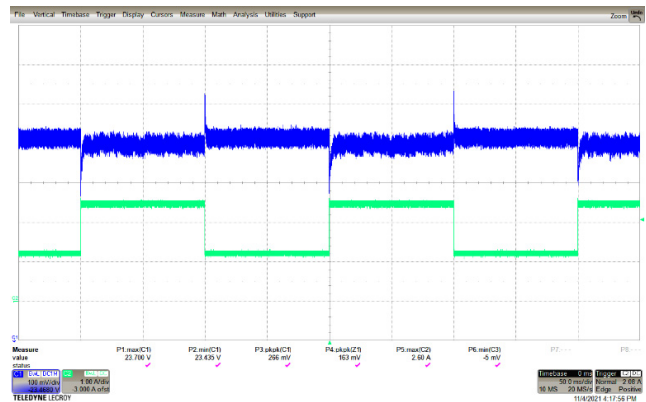
**Figure 67** – Output Load Transient, 100-50% Load.  
 $V_{IN} = 300$  VDC,  $I_{OUT} = 2.5$  A to 1.25 A.  
 $V_{OUT(MAX)} = 23.56$  V,  $V_{OUT(MIN)} = 23.38$  V.  
 Upper:  $V_{OUT}$ , 100 mV, 50 ms / div.  
 Lower:  $I_{OUT}$ , 1 A, 50 ms / div.



**Figure 68** – Output Load Transient, 100-50% Load.  
 $V_{IN} = 500$  VDC,  $I_{OUT} = 2.5$  A to 1.25 A.  
 $V_{OUT(MAX)} = 23.61$  V,  $V_{OUT(MIN)} = 23.44$  V.  
 Upper:  $V_{OUT}$ , 100 mV, 50 ms / div.  
 Lower:  $I_{OUT}$ , 1 A, 50 ms / div.

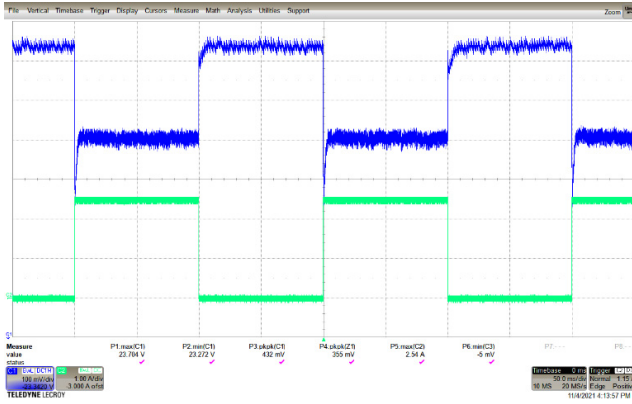


**Figure 69** – Output Load Transient, 100-50% Load.  
 $V_{IN} = 800$  VDC,  $I_{OUT} = 2.5$  A to 1.25 A.  
 $V_{OUT(MAX)} = 23.63$  V,  $V_{OUT(MIN)} = 23.45$  V.  
 Upper:  $V_{OUT}$ , 100 mV, 50 ms / div.  
 Lower:  $I_{OUT}$ , 1 A, 50 ms / div.

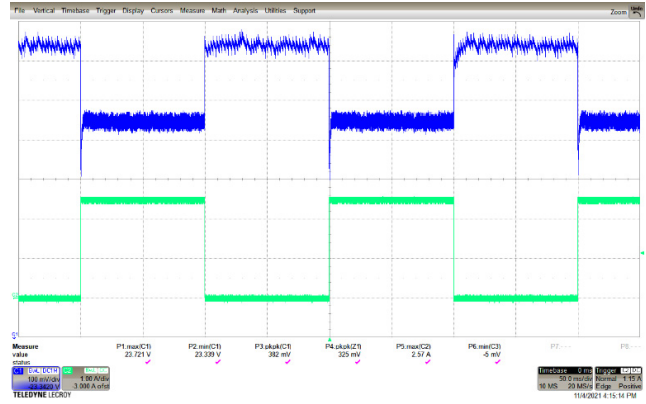


**Figure 70** – Output Load Transient, 100-50% Load.  
 $V_{IN} = 1000$  VDC,  $I_{OUT} = 2.5$  A to 1.25 A.  
 $V_{OUT(MAX)} = 23.70$  V,  $V_{OUT(MIN)} = 23.44$  V.  
 Upper:  $V_{OUT}$ , 100 mV, 50 ms / div.  
 Lower:  $I_{OUT}$ , 1 A, 50 ms / div.

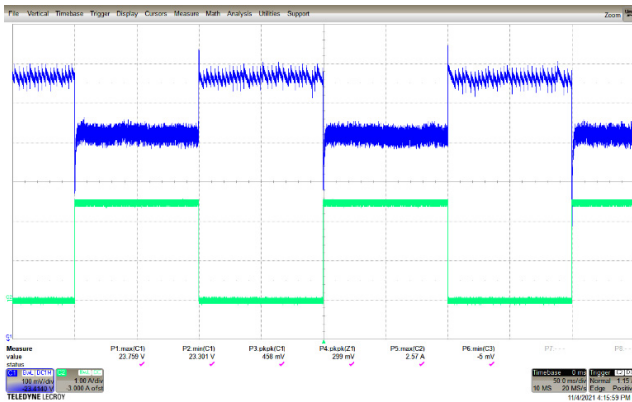
## 9.9.2 Output Load Transient, 100% to 0% Load



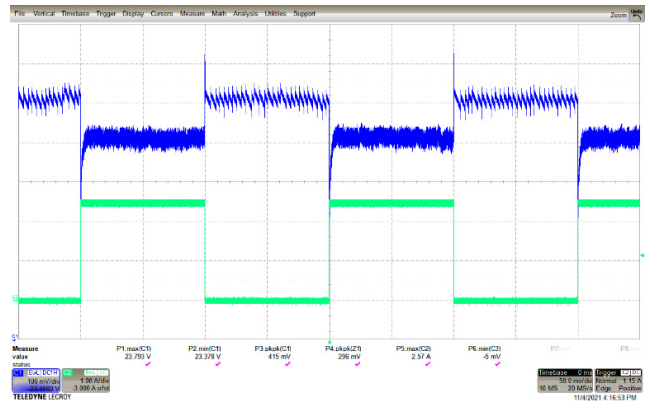
**Figure 71** – Output Load Transient, 100-0% Load.  
 $V_{IN} = 300 \text{ VDC}$ ,  $I_{OUT} = 2.5 \text{ A}$  to 0 A.  
 $V_{OUT(MAX)} = 23.70 \text{ V}$ ,  $V_{OUT(MIN)} = 23.27 \text{ V}$ .  
 Upper:  $V_{OUT}$ , 100 mV, 50 ms / div.  
 Lower:  $I_{OUT}$ , 1 A, 50 ms / div.



**Figure 72** – Output Load Transient, 100-0% Load.  
 $V_{IN} = 500 \text{ VDC}$ ,  $I_{OUT} = 2.5 \text{ A}$  to 0 A.  
 $V_{OUT(MAX)} = 23.72 \text{ V}$ ,  $V_{OUT(MIN)} = 23.34 \text{ V}$ .  
 Upper:  $V_{OUT}$ , 100 mV, 50 ms / div.  
 Lower:  $I_{OUT}$ , 1 A, 50 ms / div.

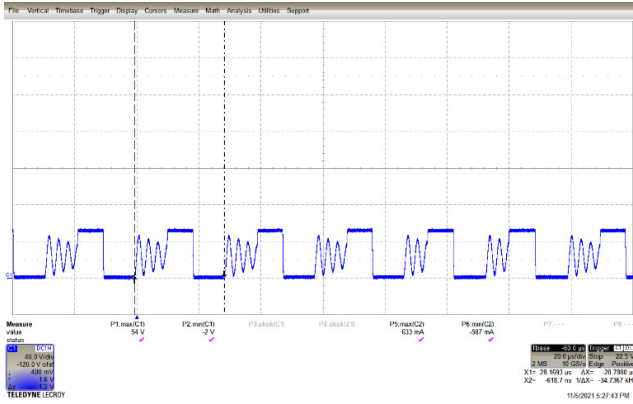


**Figure 73** – Output Load Transient, 100-0% Load.  
 $V_{IN} = 800 \text{ VDC}$ ,  $I_{OUT} = 2.5 \text{ A}$  to 0 A.  
 $V_{OUT(MAX)} = 23.76 \text{ V}$ ,  $V_{OUT(MIN)} = 23.0 \text{ V}$ .  
 Upper:  $V_{OUT}$ , 100 mV, 50 ms / div.  
 Lower:  $I_{OUT}$ , 1 A, 50 ms / div.

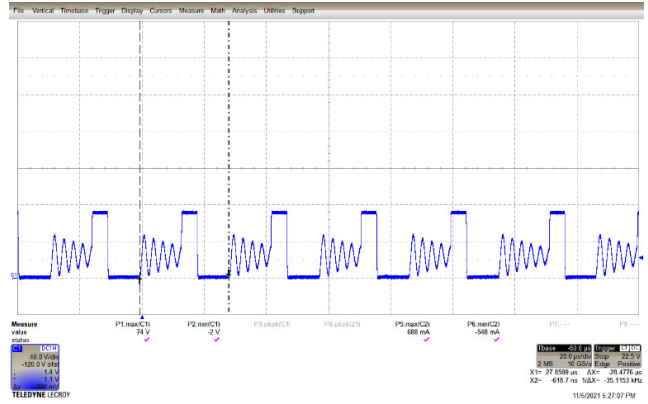


**Figure 74** – Output Load Transient, 100-0% Load.  
 $V_{IN} = 1000 \text{ VDC}$ ,  $I_{OUT} = 2.5 \text{ A}$  to 0 A.  
 $V_{OUT(MAX)} = 23.79 \text{ V}$ ,  $V_{OUT(MIN)} = 23.38 \text{ V}$ .  
 Upper:  $V_{OUT}$ , 100 mV, 50 ms / div.  
 Lower:  $I_{OUT}$ , 1 A, 50 ms / div.

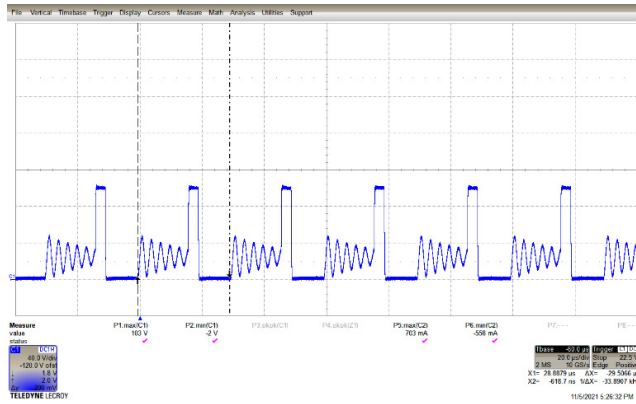
### 9.10 FWD Waveforms, Steady-State



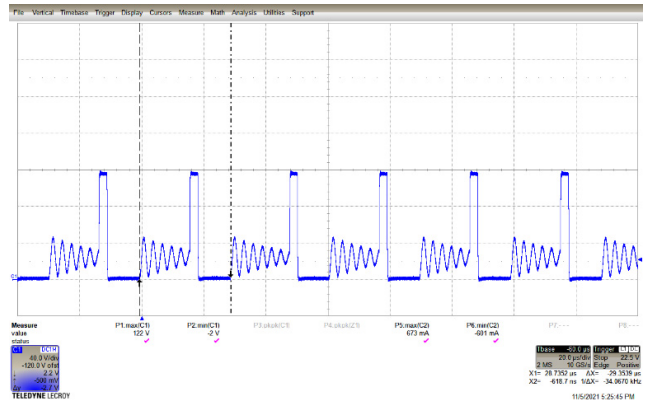
**Figure 75** – FWD Voltage During Steady State.  
 $V_{IN} = 300 \text{ VDC}$   $V_{FWD(MAX)} = 54 \text{ V}$ .  
 CH1:  $V_{FWD}$ , 40 V, 20  $\mu\text{s}$  / div.



**Figure 76** – FWD Voltage During Steady State.  
 $V_{IN} = 500 \text{ VDC}$   $V_{FWD(MAX)} = 74 \text{ V}$ .  
 CH1:  $V_{FWD}$ , 40 V, 20  $\mu\text{s}$  / div.

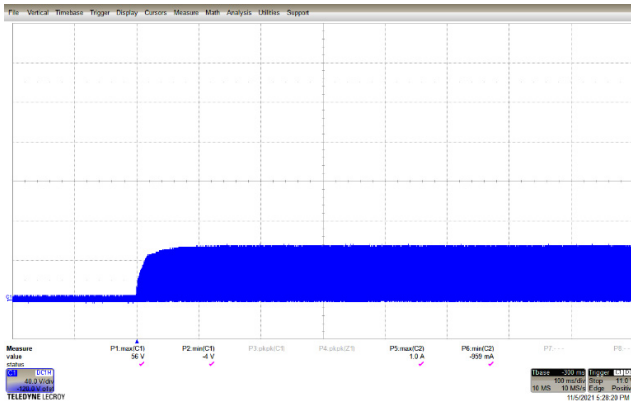


**Figure 77** – FWD Voltage During Steady State.  
 $V_{IN} = 800 \text{ VDC}$   $V_{FWD(MAX)} = 103 \text{ V}$ .  
 CH1:  $V_{FWD}$ , 40 V, 20  $\mu\text{s}$  / div.

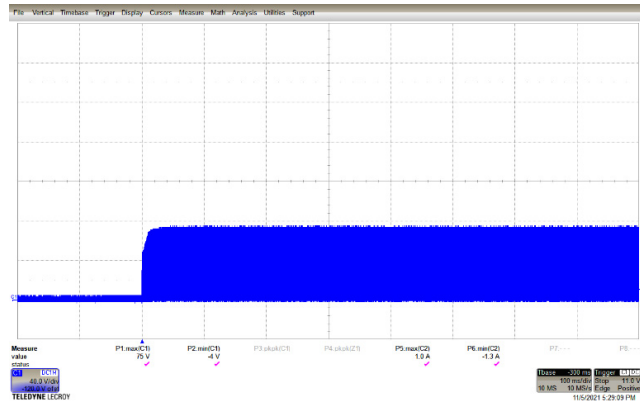


**Figure 78** – FWD Voltage During Steady State.  
 $V_{IN} = 1000 \text{ VDC}$   $V_{FWD(MAX)} = 122 \text{ V}$ .  
 CH1:  $V_{FWD}$ , 30 V, 20  $\mu\text{s}$  / div.

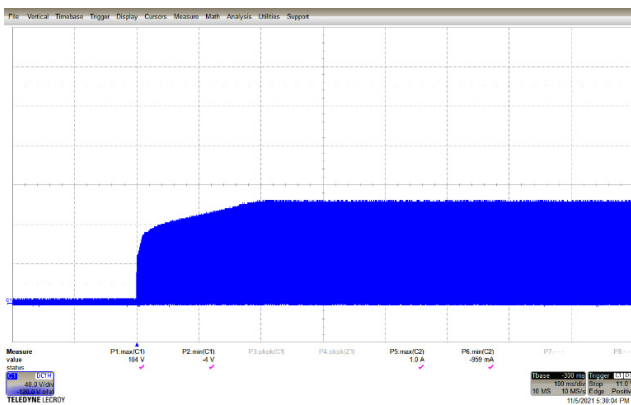
## 9.11 FWD Waveforms, Start-up



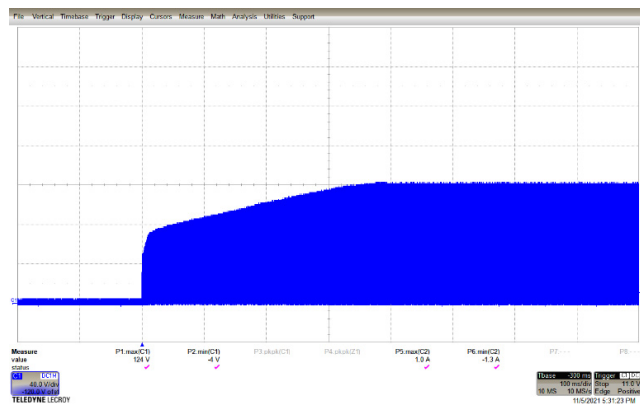
**Figure 79** – FWD Voltage During Start-up.  
 $V_{IN} = 300 \text{ VDC}$   $V_{FWD(MAX)} = 56 \text{ V}$ .  
 CH1:  $V_{FWD}$ , 40 V, 100 ms / div.



**Figure 80** – FWD Voltage During Start-up.  
 $V_{IN} = 500 \text{ VDC}$   $V_{FWD(MAX)} = 75 \text{ V}$ .  
 CH1:  $V_{FWD}$ , 40 V, 100 ms / div.

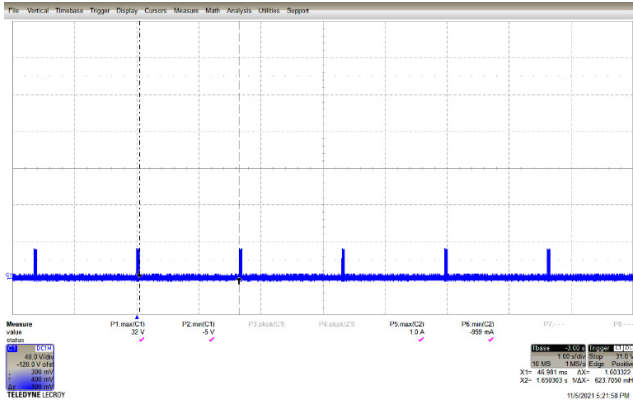


**Figure 81** – FWD Voltage During Start-up.  
 $V_{IN} = 800 \text{ VDC}$   $V_{FWD(MAX)} = 104 \text{ V}$ .  
 CH1:  $V_{FWD}$ , 40 V, 100 ms / div.

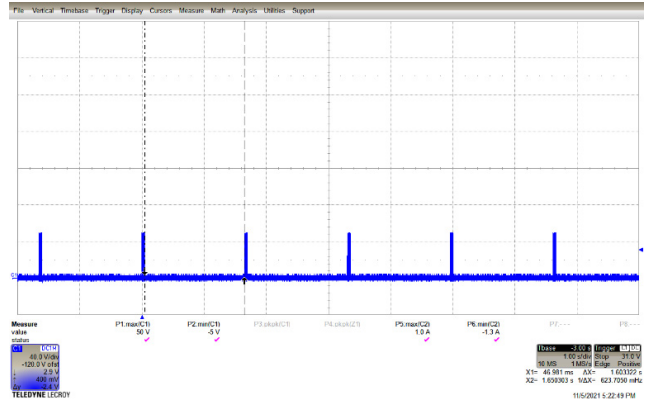


**Figure 82** – FWD Voltage During Start-up.  
 $V_{IN} = 1000 \text{ VDC}$   $V_{FWD(MAX)} = 124 \text{ V}$ .  
 CH1:  $V_{FWD}$ , 40 V, 100 ms / div.

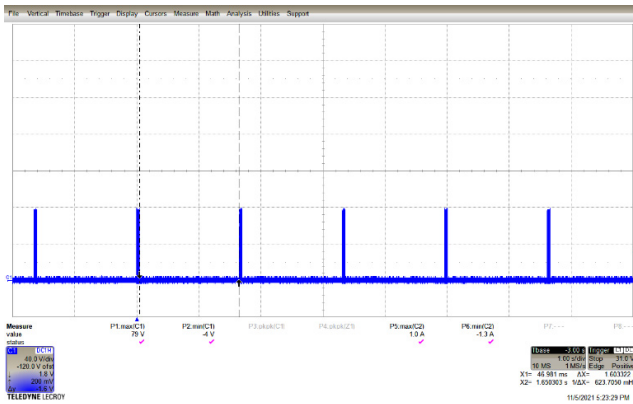
### 9.12 FWD Waveforms, Output Shorted



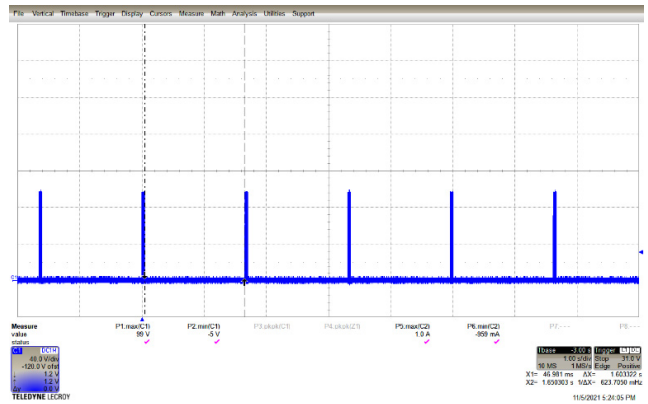
**Figure 83** – FWD Voltage During Output Short.  
 $V_{IN} = 300 \text{ VDC}$   $V_{FWD(MAX)} = 32 \text{ V}$ .  
 CH1:  $V_{FWD}$ , 40 V, 1 s / div.



**Figure 84** – FWD Voltage During Output Short.  
 $V_{IN} = 500 \text{ VDC}$   $V_{FWD(MAX)} = 50 \text{ V}$ .  
 CH1:  $V_{FWD}$ , 40 V, 1 s / div.



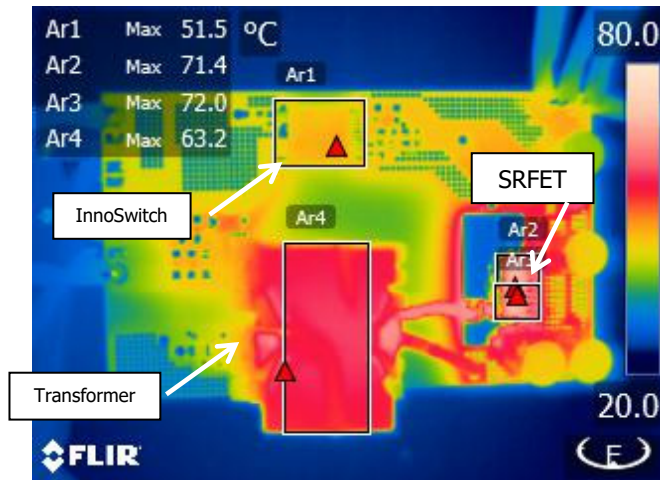
**Figure 85** – FWD Voltage During Output Short.  
 $V_{IN} = 800 \text{ VDC}$   $V_{FWD(MAX)} = 79 \text{ V}$ .  
 CH1:  $V_{FWD}$ , 40 V, 1 s / div.



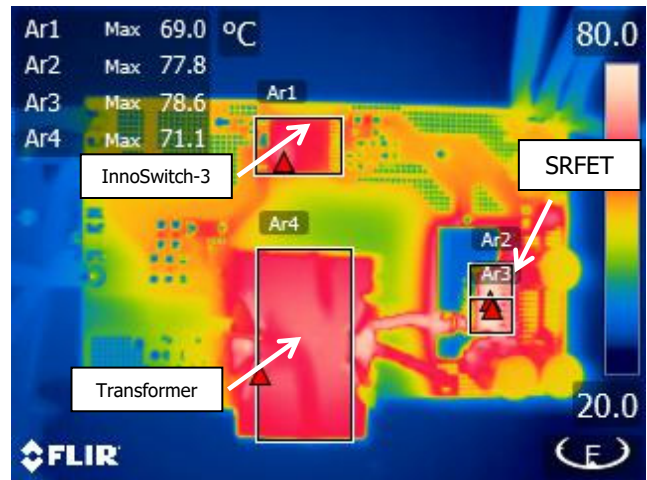
**Figure 86** – FWD Voltage During Output Short  
 $V_{IN} = 1000 \text{ VDC}$   $V_{FWD(MAX)} = 99 \text{ V}$ .  
 CH1:  $V_{FWD}$ , 40 V, 1 s / div.

## 10 Thermal Performance

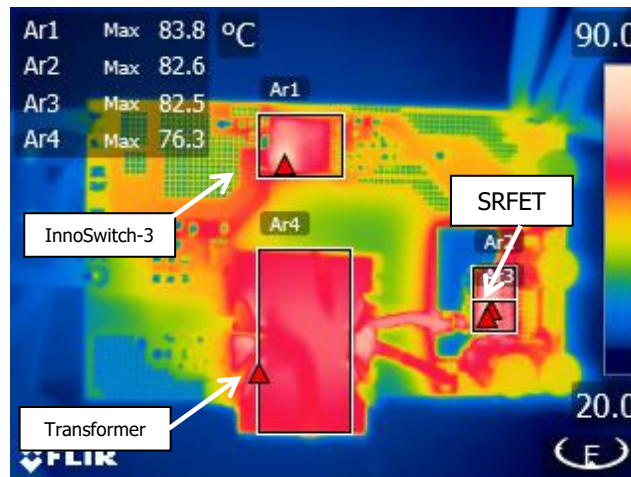
All measurements have been done at room ambient temperature after 1 hour of continuous operation.



**Figure 87** – 300 VDC 2.5 A Full Load.  
 Temperature of INN3949CQ: 51.5 °C.  
 Temperature of SR FET1 (Q2): 71.4 °C.  
 Temperature of SR FET2 (Q3): 72.0 °C.  
 Temperature of Transformer: 63.2 °C.  
 Ambient Temperature: 24.9 °C.



**Figure 88** – 800 VDC 2.5 A Full Load.  
 Temperature of INN3949CQ: 69.0 °C.  
 Temperature of SR FET1 (Q2): 77.8 °C.  
 Temperature of SR FET2 (Q3): 78.6 °C.  
 Temperature of Transformer: 71.1 °C.  
 Ambient Temperature: 25.7 °C.



**Figure 89** – 1000 VDC 2.5 A Full Load.  
 Temperature of INN3947CQ: 83.8 °C.  
 Temperature of SR FET1 (Q2): 82.6 °C.  
 Temperature of SR FET2 (Q3): 82.5 °C.  
 Temperature of Transformer: 76.3 °C.  
 Ambient Temperature: 26.4 °C.



### 10.1 *Temperature vs. Output Power*

Data below is taken with no additional thermal mitigation.

Available output power at elevated ambient can be increased by providing a thermal path from the PCB area connected to the SOURCE pin of the InnoSwitch3-AQ to a surface that is lower in temperature. This is typically the outer wall of the inverter or internally above the water channel cooling the power modules. A very simple approach is a compliant thermal pad (e.g. TGP 1500 from Berquist) placed between the PCB and bottom or top surface of the enclosure.

In the design of the cast enclosure features may be added at no cost to provide a location to place the pad for manufacturing simplicity and reduce the thickness of pad needed to reduce cost of pad needed.

300 VDC								
P <sub>IN</sub> (W)	V <sub>OUT</sub> (V)	I <sub>OUT</sub> (A)	P <sub>OUT</sub> (W)	Efficiency (%)	INN3949CQ (°C)	AMB (°C)	INN3949CQ Trise (°C)	Projected Max AMB Operating Temp (125 °C - Trise)
10.90	23.68	0.42	9.91	90.9	35.8	24.2	11.6	113.4
21.42	23.67	0.84	19.84	92.6	39.7	24.5	15.2	109.8
31.94	23.68	1.26	29.79	93.3	42.5	24.7	17.8	107.2
42.08	23.65	1.66	39.32	93.5	45.2	25.0	20.2	104.8
52.56	23.58	2.08	49.08	93.4	46.6	25.1	21.5	103.5
63.26	23.59	2.5	59.04	93.3	51.5	26.4	25.1	99.9

300 VDC								
P <sub>IN</sub> (W)	V <sub>OUT</sub> (V)	I <sub>OUT</sub> (A)	P <sub>OUT</sub> (W)	Efficiency (%)	INN3949CQ (°C)	AMB (°C)	INN3949CQ Trise (°C)	Projected Max AMB Operating Temp (125 °C - Trise)
11.03	23.69	0.42	9.91	89.8	38.0	24.5	13.5	111.5
21.57	23.69	0.84	19.85	92.0	41.6	25.1	16.5	108.5
32.14	23.72	1.26	29.84	92.8	44.5	25.1	19.4	105.6
42.30	23.68	1.66	39.39	93.1	45.0	24.3	20.7	104.3
52.81	23.63	2.08	49.17	93.1	49.2	24.4	24.8	100.2
63.47	23.62	2.50	59.11	93.1	50.8	24.5	26.3	98.7





<b>500 VDC</b>								
<b>P<sub>IN</sub> (W)</b>	<b>V<sub>OUT</sub> (V)</b>	<b>I<sub>OUT</sub> (A)</b>	<b>P<sub>OUT</sub> (W)</b>	<b>Efficiency (%)</b>	<b>INN3949CQ (°C)</b>	<b>AMB (°C)</b>	<b>INN3949CQ Trise (°C)</b>	<b>Projected Max AMB Operating Temp (125°C - Trise)</b>
11.19	23.70	0.42	9.91	88.6	38.8	24.2	14.6	110.4
21.77	23.70	0.84	19.86	91.2	41.5	24	17.5	107.5
32.44	23.73	1.26	29.85	92.0	46.4	24.5	21.9	103.1
42.54	23.70	1.66	39.41	92.6	49.2	25.5	23.7	101.3
53.18	23.69	2.08	49.31	92.7	52.0	25.7	26.3	98.7
63.83	23.68	2.50	59.27	92.9	54.4	24.5	29.9	95.1

<b>600 VDC</b>								
<b>P<sub>IN</sub> (W)</b>	<b>V<sub>OUT</sub> (V)</b>	<b>I<sub>OUT</sub> (A)</b>	<b>P<sub>OUT</sub> (W)</b>	<b>Efficiency (%)</b>	<b>INN3949CQ (°C)</b>	<b>AMB (°C)</b>	<b>INN3949CQ Trise (°C)</b>	<b>Projected Max AMB Operating Temp (125 °C - Trise)</b>
11.38	23.71	0.42	9.92	87.2	41.4	23.8	17.6	107.4
22.02	23.71	0.84	19.87	90.2	47.1	24.0	23.1	101.9
32.70	23.75	1.26	29.88	91.4	51.2	24.0	27.2	97.8
43.22	23.73	1.66	39.46	91.3	52.1	23.8	28.3	96.7
53.45	23.69	2.08	49.30	92.2	54.6	24.3	30.3	94.7
64.15	23.68	2.50	59.27	92.4	56.0	24.2	31.8	93.2

<b>700 VDC</b>								
<b>P<sub>IN</sub> (W)</b>	<b>V<sub>OUT</sub> (V)</b>	<b>I<sub>OUT</sub> (A)</b>	<b>P<sub>OUT</sub> (W)</b>	<b>Efficiency (%)</b>	<b>INN3949CQ (°C)</b>	<b>AMB (°C)</b>	<b>INN3949CQ Trise (°C)</b>	<b>Projected Max AMB Operating Temp (125 °C - Trise)</b>
11.56	23.72	0.42	9.92	85.8	42.8	23.3	19.5	105.5
22.31	23.72	0.84	19.88	89.1	49.1	23.3	25.8	99.2
32.97	23.75	1.26	29.88	90.6	52.9	23.3	29.6	95.4
43.59	23.74	1.66	39.48	90.6	58.4	25.8	32.6	92.4
53.93	23.76	2.08	49.44	91.7	60.7	25.9	34.8	90.2
64.56	23.69	2.50	59.31	91.9	63.1	25.6	37.5	87.5



800 VDC								
P <sub>IN</sub> (W)	V <sub>OUT</sub> (V)	I <sub>OUT</sub> (A)	P <sub>OUT</sub> (W)	Efficiency (%)	INN3949CQ (°C)	AMB (°C)	INN3949CQ Trise (°C)	Projected Max AMB Operating Temp (125 °C - Trise)
11.75	23.74	0.42	9.93	84.5	46.9	24.9	22	103
22.63	23.74	0.84	19.90	87.9	56.3	25.2	31.1	93.9
33.37	23.77	1.26	29.91	89.6	61.7	25.7	36	89
44.01	23.77	1.66	39.54	89.8	63.2	25.8	37.4	87.6
54.43	23.76	2.08	49.45	90.8	65.6	25.8	39.8	85.2
65.31	23.78	2.50	59.52	91.1	69.0	25.7	43.3	81.7

900 VDC								
P <sub>IN</sub> (W)	V <sub>OUT</sub> (V)	I <sub>OUT</sub> (A)	P <sub>OUT</sub> (W)	Efficiency (%)	INN3949CQ (°C)	AMB (°C)	INN3949CQ Trise (°C)	Projected Max AMB Operating Temp (125 °C - Trise)
12.01	23.76	0.42	9.94	82.7	50.3	25.3	25	100
22.93	23.75	0.84	19.90	86.8	61.2	25.6	35.6	89.4
33.82	23.78	1.26	29.92	88.5	67.2	25.9	41.3	83.7
44.55	23.81	1.66	39.60	88.9	71.2	25.9	45.3	79.7
54.83	23.76	2.08	49.46	90.2	72.8	26.2	46.6	78.4
65.76	23.77	2.50	59.49	90.5	75.6	26.3	49.3	75.7

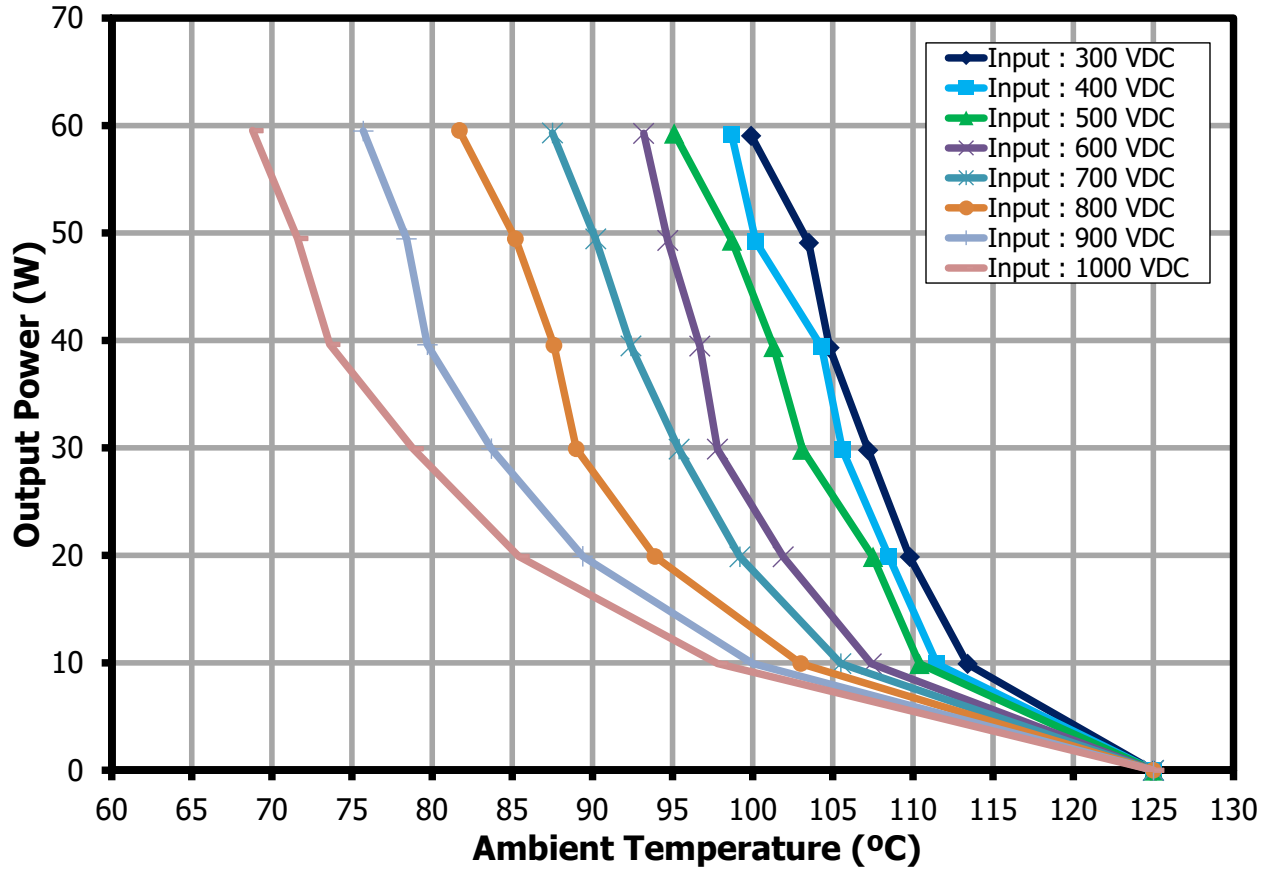
1000 VDC								
P <sub>IN</sub> (W)	V <sub>OUT</sub> (V)	I <sub>OUT</sub> (A)	P <sub>OUT</sub> (W)	Efficiency (%)	INN3949CQ (°C)	AMB (°C)	INN3949CQ Trise (°C)	Projected Max AMB Operating Temp (125 °C - Trise)
12.26	23.77	0.42	9.94	81.1	52.5	25.3	27.2	97.8
23.18	23.76	0.84	19.92	85.9	65.3	25.7	39.6	85.4
34.21	23.79	1.26	29.93	87.5	72.0	25.8	46.2	78.8
44.90	23.84	1.66	39.64	88.3	77.9	26.5	51.4	73.7
55.38	23.78	2.08	49.49	89.4	80.1	26.7	53.4	71.6
66.24	23.79	2.50	59.54	89.9	83.8	27.6	56.2	68.8



**10.2 Maximum Output Power vs. Ambient Temperature**

(Based on 125 °C junction temperature of INN3949CQ)

Data below is taken with no additional thermal mitigation



**Figure 90** – Maximum Output Power vs. Ambient Temperature.

**11 Revision History**

<b>Date</b>	<b>Author</b>	<b>Revision</b>	<b>Description &amp; Changes</b>	<b>Reviewed</b>
17-Jan-22	JMR	1.0	Initial Release	Mktg & Apps
10-Feb-23	KM	1.1	Added Supplier for T1	Mktg & Apps



For the latest updates, visit our website: [www.power.com](http://www.power.com)

Reference Designs are technical proposals concerning how to use Power Integrations' gate drivers in particular applications and/or with certain power modules. These proposals are "as is" and are not subject to any qualification process. The suitability, implementation and qualification are the sole responsibility of the end user. The statements, technical information and recommendations contained herein are believed to be accurate as of the date hereof. All parameters, numbers, values and other technical data included in the technical information were calculated and determined to our best knowledge in accordance with the relevant technical norms (if any). They may base on assumptions or operational conditions that do not necessarily apply in general. We exclude any representation or warranty, express or implied, in relation to the accuracy or completeness of the statements, technical information and recommendations contained herein. No responsibility is accepted for the accuracy or sufficiency of any of the statements, technical information, recommendations or opinions communicated and any liability for any direct, indirect or consequential loss or damage suffered by any person arising therefrom is expressly disclaimed.

Power Integrations reserves the right to make changes to its products at any time to improve reliability or manufacturability. Power Integrations does not assume any liability arising from the use of any device or circuit described herein. POWER INTEGRATIONS MAKES NO WARRANTY HEREIN AND SPECIFICALLY DISCLAIMS ALL WARRANTIES INCLUDING, WITHOUT LIMITATION, THE IMPLIED WARRANTIES OF MERCHANTABILITY, FITNESS FOR A PARTICULAR PURPOSE, AND NON-INFRINGEMENT OF THIRD PARTY RIGHTS.

#### Patent Information

The products and applications illustrated herein (including transformer construction and circuits' external to the products) may be covered by one or more U.S. and foreign patents, or potentially by pending U.S. and foreign patent applications assigned to Power Integrations. A complete list of Power Integrations' patents may be found at [www.power.com](http://www.power.com). Power Integrations grants its customers a license under certain patent rights as set forth at <http://www.power.com/ip.htm>.

Power Integrations, the Power Integrations logo, CAPZero, ChiPhy, CHY, DPA-Switch, EcoSmart, E-Shield, eSIP, eSOP, HiperPLC, HiperPFS, HiperTFS, InnoSwitch, Innovation in Power Conversion, InSOP, LinkSwitch, LinkZero, LYTSwitch, SENZero, TinySwitch, TOPSwitch, PI, PI Expert, PowiGaN, SCALE, SCALE-1, SCALE-2, SCALE-3 and SCALE-iDriver, are trademarks of Power Integrations, Inc. Other trademarks are property of their respective companies. ©2019, Power Integrations, Inc.

### Power Integrations Worldwide Sales Support Locations

#### WORLD HEADQUARTERS

5245 Hellyer Avenue  
San Jose, CA 95138, USA.  
Main: +1-408-414-9200  
Customer Service:  
Worldwide: +1-65-635-64480  
Americas: +1-408-414-9621  
e-mail: [usasales@power.com](mailto:usasales@power.com)

#### CHINA (SHANGHAI)

Rm 2410, Charity Plaza, No. 88,  
North Caoxi Road,  
Shanghai, PRC 200030  
Phone: +86-21-6354-6323  
e-mail: [chinasales@power.com](mailto:chinasales@power.com)

#### CHINA (SHENZHEN)

17/F, Hivac Building, No. 2, Keji  
Nan 8th Road, Nanshan District,  
Shenzhen, China, 518057  
Phone: +86-755-8672-8689  
e-mail: [chinasales@power.com](mailto:chinasales@power.com)

#### GERMANY (AC-DC/LED Sales)

Einsteinring 24  
85609 Dornach/Aschheim  
Germany  
Tel: +49-89-5527-39100  
e-mail: [eurosales@power.com](mailto:eurosales@power.com)

#### GERMANY (Gate Driver Sales)

HellwegForum 1  
59469 Ense  
Germany  
Tel: +49-2938-64-39990  
e-mail: [igbt-driver.sales@power.com](mailto:igbt-driver.sales@power.com)

#### INDIA

#1, 14<sup>th</sup> Main Road  
Vasanthanagar  
Bangalore-560052  
India  
Phone: +91-80-4113-8020  
e-mail: [indiasales@power.com](mailto:indiasales@power.com)

#### ITALY

Via Milanese 20, 3<sup>rd</sup>. Fl.  
20099 Sesto San Giovanni (MI) Italy  
Phone: +39-024-550-8701  
e-mail: [eurosales@power.com](mailto:eurosales@power.com)

#### JAPAN

Yusen Shin-Yokohama 1-chome Bldg.  
1-7-9, Shin-Yokohama, Kohoku-ku  
Yokohama-shi,  
Kanagawa 222-0033 Japan  
Phone: +81-45-471-1021  
e-mail: [japansales@power.com](mailto:japansales@power.com)

#### KOREA

RM 602, 6FL  
Korea City Air Terminal B/D,  
159-6  
Samsung-Dong, Kangnam-Gu,  
Seoul, 135-728 Korea  
Phone: +82-2-2016-6610  
e-mail: [koreasales@power.com](mailto:koreasales@power.com)

#### SINGAPORE

51 Newton Road,  
#19-01/05 Goldhill Plaza  
Singapore, 308900  
Phone: +65-6358-2160  
e-mail:  
[singaporesales@power.com](mailto:singaporesales@power.com)

#### TAIWAN

5F, No. 318, Nei Hu Rd.,  
Sec. 1  
Nei Hu District  
Taipei 11493, Taiwan R.O.C.  
Phone: +886-2-2659-4570  
e-mail: [taiwansales@power.com](mailto:taiwansales@power.com)

#### UK

Building 5, Suite 21  
The Westbrook Centre  
Milton Road  
Cambridge  
CB4 1YG  
Phone: +44 (0) 7823-557484  
e-mail: [eurosales@power.com](mailto:eurosales@power.com)



**Power Integrations, Inc.**

Tel: +1 408 414 9200 Fax: +1 408 414 9201  
[www.power.com](http://www.power.com)